

FITTING INSTRUCTION

Clamp mark in acc. with		Cables joining
ISO	PN	
1	L	Left directional lights
2	+	Rear fog lights
3	31	Ground
4	R	Right directional lights
5	58R	Right side parking lights
6	54	Stoplights
7	58L	Left side parking lights

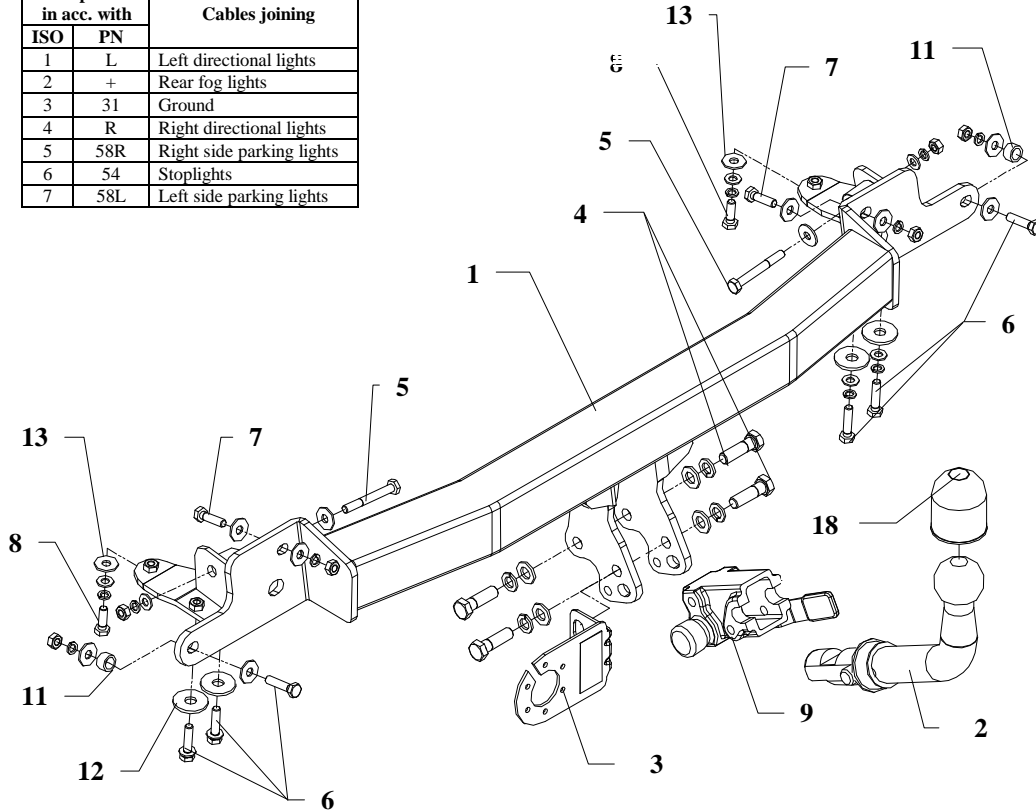

Fig.1

This towbar is designed to assembly in following cars:

TOYOTA COROLLA 3-5 doors, produced since 05.1992 till 06.1997 catalogue no. **O58A** and is prepared to tow trailers max total weight **1300 kg** and max vertical load **75 kg**.

From manufacturer

Thank you for buying our product. Their reliability has been confirmed in many tests. Reliability of towbar depends also on correct assembly and right exploit. For this reasons we kindly ask to read carefully this instruction and apply to hints.

The towbar should be install in points described by a car producer.

Fitting instructions

1. Disassemble a bumper and next take out his reinforcement. In place for reinforcement will be mounted our towbar.
2. Disassemble rear muffler and his fastener.
3. Remove towing eye – not used any more.
4. Slip main bar of towbar (pos. 1) to rear chassis members and screw using bolts, nuts and sleeves – as shown in the figure 1.
5. Assemble fastener and muffler.
6. Assemble bumper after cut his fragment in his lower part.
7. Tighten all bolts according to the torque shown in the table.
8. Fix body of the automat (pos. 9) and the socket plate (pos. 3) using bolts M12x25mm (pos. 4) from accessories. Place tow-ball (pos. 2) according to supplied instruction.
9. Connect electric wires of 7-poles socket according to the instruction of the car. (Recommend to make at authorized service station)
10. Complete the paint coating damaged during installation.

Torque settings for nuts and bolts (8,8):

M 8 25 Nm
M 12 85 Nm

M 10 55 Nm
M 14 135 Nm











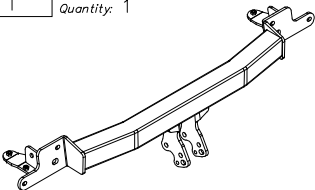

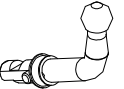

NOTE

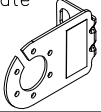
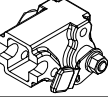
After install the towbar you should get adequate registration in registration book (at authorised service station).The car should be equipped with:

- Indicators
- Tow mirrors

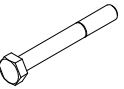
After 1000km check all bolts and nuts. The ball of towbar must be always kept clear and conserve with a grease.

Towbar accessories:

Pos. 1 Name: Main bar Quantity: 1 	Pos. 6 Name: Bolt 8,8 B Quantity: 6 Dim.: M8x35mm 	Pos. 13 Name: Washer Quantity: 12 Dim.: Ø24xØ9x2mm 
	Pos. 7 Name: Bolt 8,8 B Quantity: 2 Dim.: M8x30mm 	Pos. 14 Name: Plain washer Quantity: 4 Dim.: Ø13mm 
Pos. 2 Name: Tow ball Quantity: 1 	Pos. 8 Name: Bolt 8,8 B Quantity: 2 Dim.: M8x25mm 	Pos. 15 Name: Plain washer Quantity: 8 Dim.: Ø8,5mm 
Pos. 3 Name: Socket plate Quantity: 1 	Pos. 9 Name: Body of the automat Quantity: 1 	Pos. 16 Name: Spring washer Quantity: 4 Dim.: Ø12,2 
Pos. 4 Name: Bolt 8,8 B Quantity: 4 Dim.: M12x25mm 	Pos. 10 Name: Nut 8 B Quantity: 6 Dim.: M8 	Pos. 17 Name: Spring washer Quantity: 12 Dim.: Ø8,2mm 
Pos. 5 Name: Bolt 8,8 B Quantity: 2 Dim.: M8x65mm 	Pos. 11 Name: Sleeve Quantity: 2 Dim.: Ø17,2x2,35 L=10 	Pos. 18 Name: Ball cover Quantity: 1 
	Pos. 12 Name: Washer Quantity: 4 Dim.: Ø35xØ12x3mm 	Pos. 19 Name: Body plug Quantity: 1 



PPUH AUTO-HAK S.J.

Produkcja Haków Holowniczych
Henryk & Zbigniew Nejman
76-200 SŁUPSK ul. Słoneczna 16K
tel/fax (059) 8-414-414; 8-414-413
E-mail: office@autohak.com.pl
www. autohak.com.pl

Towing hitch (without electrical set)

Class: **A50-X** Cat. no. **O58A**

Designed for:

Manufacturer: **TOYOTA**

Model: **COROLLA**

Type: **3-5 doors**

produced since **05.1992 till 06.1997**

Technical data:

D-value: 7,05 kN

maximum trailer weight: **1300 kg**

maximum vertical cup load: **75 kg**

Approval number acc. to regulations EKG/ONZ 55.01: **E20-55R-01 1343**

Foreword

This towbar is design according to rules of safety traffic regulations. The towing hitch is a safety component and must be installed only by qualified personnel. Any alteration or conversion to the towinh hitch is prohibited and would lead to cancellation of design certification. Remove insulating compound and underseal from vehicle (if present) in the area of the matting surfaces of the towing hitch.

The vehicle manufacturer's specifications regarding trailer load and max. vertical cup load are decisive for driving, and values for the towing hitch cannot be exceeded.

D-value formula:

$$\frac{\text{Max trailer weight [kg]} \times \text{Max vehicle weight [kg]}}{\text{Max trailer weight [kg]} + \text{Max vehicle weight [kg]}} \times \frac{9,81}{1000} = D \text{ [kN]}$$