

FITTING INSTRUCTION

Clamp mark in acc. with		Cables joining
ISO	PN	
1	L	Left directional lights
2	+	Rear fog lights
3	31	Ground
4	R	Right directional lights
5	58R	Right side parking lights
6	54	Stoptlights
7	58L	Left side parking lights

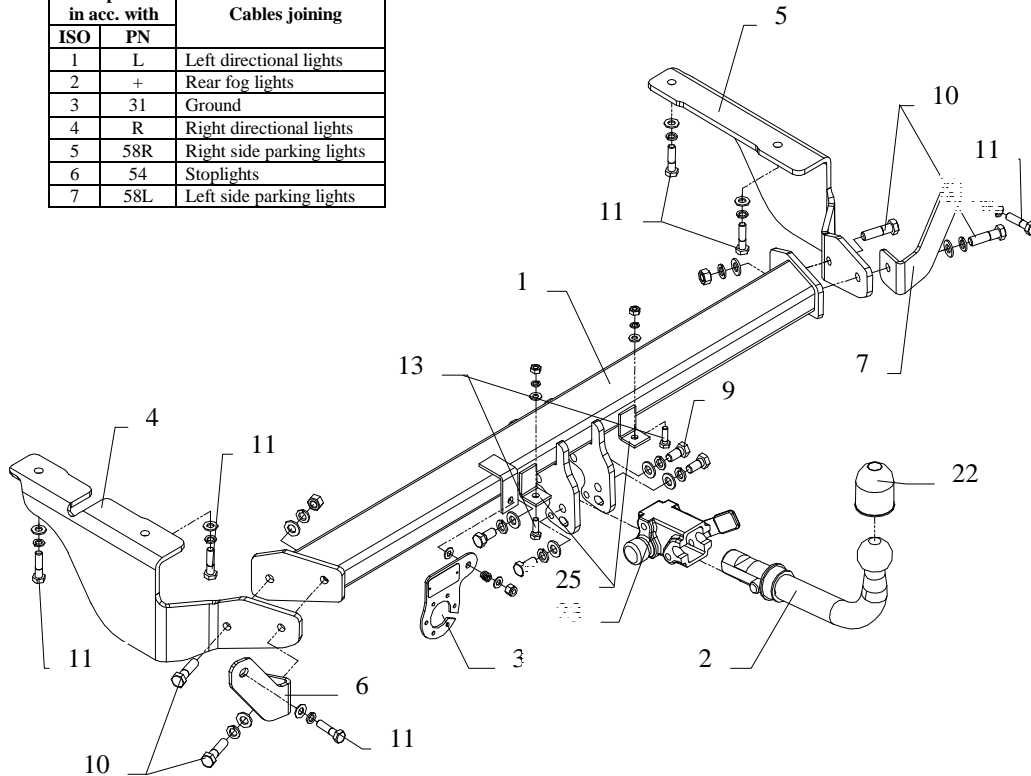

This towbar is designed to assembly in following cars:
CITROEN C5 II ESTATE, produced since 10.2004 till 03.2008,
 catalogue no. **P30A** and is prepared to tow trailers max total weight
1600 kg and max vertical load **85 kg**.

From manufacturer

Thank you for buying our product. Their reliability has been confirmed in many tests. Reliability of towbar depends also on correct assembly and correct exploitation. For this reasons we kindly ask to read carefully this instruction and apply to hints.

The towbar should be install in points described by a car producer.

The instruction of the assembly

1. Underneath of the bumper unfix plastic spoiler (not used any more).
2. In original prepared points fix loosely side brackets (pos. 4 and 5) using bolts M10x40mm (pos. 11).
3. Slip main bar of the towbar (pos. 1) between side brackets and fix it by bolts M12x45mm (pos. 10). Remember about angle elements (pos. 6 and 7).
4. To handles pos. 25 fix the bumper by bolts M8x25mm (pos. 13).
5. Fix body of the automat (pos. 23) using bolts M12x25mm (pos. 9) from accessories. Place tow-ball (pos. 2) according to supplied instruction and socket plate (pos. 3) bolts M8 x 30 mm.
6. Tighten all bolts according to the torque shown in the table.
7. Connect electric wires of 7-poles socket according to the instruction of the car. (Recommend to make at authorized service station)
8. Complete paint layer damaged during installation.

Torque settings for nuts and bolts (8,8):

M6 - 11 Nm	M8 - 25 Nm	M10 - 50 Nm
M12 - 87 Nm	M14 - 138 Nm	M16 - 210 Nm











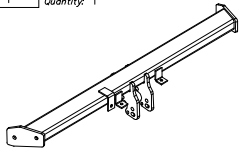
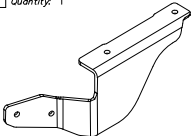

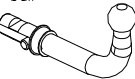







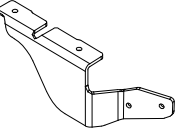

NOTE

After install the towbar you should get adequate note in registration book (at authorised service station).The car should be equipped with:

- Indicators
- Tow mirrors

After 1000km of exploitation check all bolts and nuts. The ball of towbar must be always kept clear and conserve with a grease.

Towbar accessories:

Pos. 1 Name: Main bar Quantity: 1 	Pos. 5 Name: Right bracket Quantity: 1 	Pos. 11 Name: Bolt 8,8 B Quantity: 6 Dim.: M10x40mm 	Pos. 18 Name: Plain washer Quantity: 4 Dim.: Ø 8,5 mm 
Pos. 2 Name: Tow ball Quantity: 1 	Pos. 6 Name: Right side bracket Quantity: 1 	Pos. 12 Name: Bolt 8,8 B Quantity: 1 Dim.: M8x30mm 	Pos. 19 Name: Spring washer Quantity: 8 Dim.: Ø 12,2 mm 
Pos. 3 Name: Socket plate Quantity: 1 	Pos. 7 Name: Left side bracket Quantity: 1 	Pos. 13 Name: Bolt 8,8 B Quantity: 2 Dim.: M8x25mm 	Pos. 20 Name: Spring washer Quantity: 6 Dim.: Ø 10,2 mm 
Pos. 4 Name: Left bracket Quantity: 1 	Pos. 8 Name: Spring Quantity: 1 	Pos. 14 Name: Nut 8 B Quantity: 2 Dim.: M12 	Pos. 21 Name: Spring washer Quantity: 2 Dim.: Ø 8,2 mm 
	Pos. 9 Name: Bolt 8,8 B Quantity: 4 Dim.: M12x25mm 	Pos. 15 Name: Nut 8 B Quantity: 3 Dim.: M8 	Pos. 22 Name: Ball cover Quantity: 1 
	Pos. 10 Name: Bolt 8,8 B Quantity: 4 Dim.: M12x45mm 	Pos. 16 Name: Plain washer Quantity: 8 Dim.: Ø 13 mm 	Pos. 23 Name: Body of the automat Quantity: 1 
		Pos. 17 Name: Plain washer Quantity: 6 Dim.: Ø 10,5 mm 	Pos. 24 Name: Body plug Quantity: 1 



PPUH AUTO-HAK S.J.

Produkcja Zaczepów Kulowych
Henryk & Zbigniew Nejman
76-200 SŁUPSK ul. Słoneczna 16K
tel/fax (059) 8-414-414; 8-414-413
E-mail: office@autohak.com.pl
www. autohak.com.pl

Towing hitch (without electrical set)

Class: **A50-X** Cat. no. **P30A**

Designed for:

Manufacturer: **CITROEN**

Model: **C5 II**

Type: **ESTATE**

Technical data:

D-value: 8,99 kg

maximum trailer weight: **1600 kg**

maximum vertical cup load: **85 kg**

produced since 10.2004 till 03.2008

Approval number according to Directive 94/20/EC: **e20*94/20*0806*00**

Foreword

This towbar is design according to rules of safety traffic regulations. The towing hitch is a safety component and must be installed only by qualified personnel. Any alteration or conversion to the towinh hitch is prohibited and would lead to cancellation of design certification. Remove insulating compound and underseal from vehicle (if present) in the area of the matting surfaces of the towing hitch. The vehicle manufacturer's specifications regarding trailer load and max. vertical cup load are decisive for driving, and values for the towing hitch must not be exceeded.

D-value formula:

$$\frac{\text{Max trailer weight [kg]} \times \text{Max vehicle weight [kg]}}{\text{Max trailer weight [kg]} + \text{Max vehicle weight [kg]}} \times \frac{9,81}{1000} = D \text{ [kN]}$$