

## FITTING INSTRUCTION

Clamp mark in acc. with		Cables joining
ISO	PN	
1	L	Left directional lights
2	+	Rear fog lights
3	31	Ground
4	R	Right directional lights
5	58R	Right side parking lights
6	54	Stoplights
7	58L	Left side parking lights

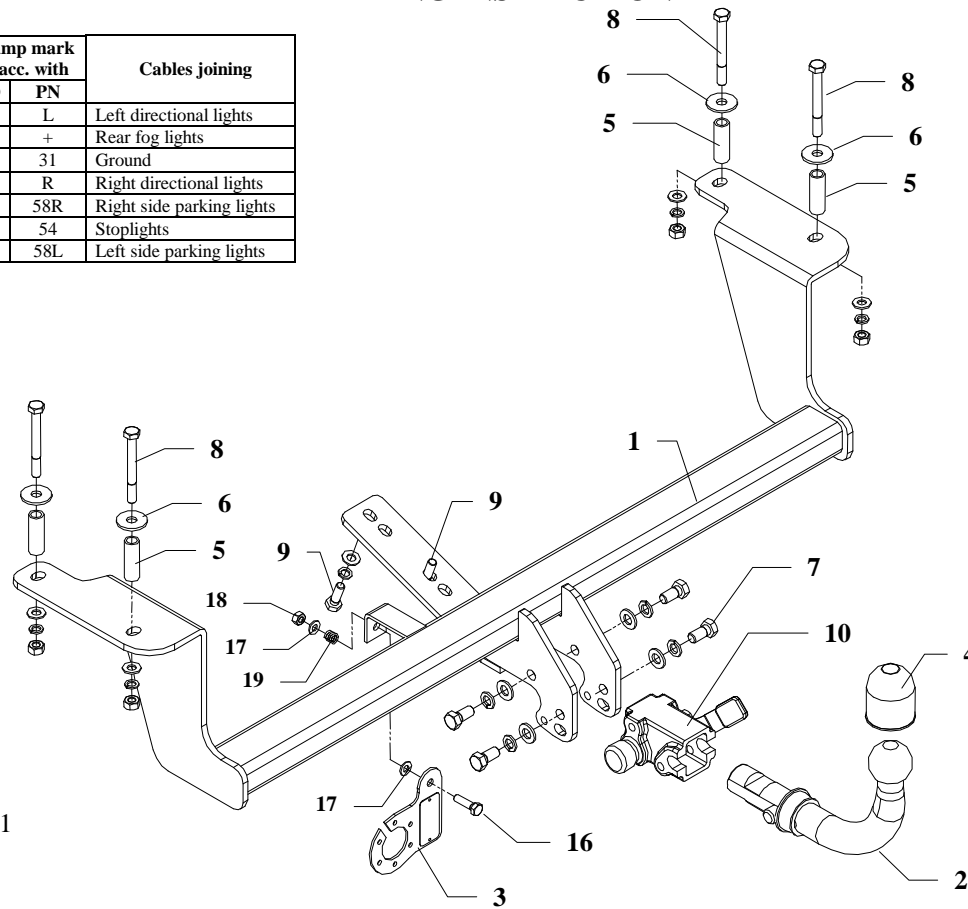

Fig.1

This towing hitch is designed to assembly in following car: **SUZUKI IGNIS 3/5 doors**, produced since 04.2003 (in Hungary), catalogue no. **W19A** and is prepared to tow trailers max total weight **800 kg** and max vertical load **50 kg**.

### *From manufacturer*

Thank you for buying our product. Their reliability has been confirmed in many tests. Reliability of towing hitch depends also on correct assembly and right operation. For this reasons we kindly ask to read carefully this instruction and apply to hints.

*The towing hitch should be install in points described by a car producer.*

## The instruction of the assembly

- To install this towing hitch You should:
  - take out carpet from boot, disassemble covers from side and rear part.
  - unscrew original tow handle (not used any more).
- From below the car are two holes  $\varnothing 12\text{mm}$  per side (per each chassis members side). Through this holes drill next holes to boot, next drill it again only in boot side using bit  $\varnothing 17\text{ mm}$  (Remember: only from boot and only in boot floor!). In this way prepared holes put distance sleeves  $L=50\text{ mm}$  (pos. 5) from towing hitch accessories.
- Put main bar of towing hitch (pos. 1) in that way, so holes in bar agree with holes in chassis members and with holes from original tow handle and screw all using bolts  $M10 \times 90\text{mm}$  (pos. 8) and  $M10 \times 35\text{mm}$  (pos. 9) – see figure.
- Tighten all bolts according to the torque shown in the table.
- Fix body of the automat (pos. 10) using bolts  $M12 \times 25\text{mm}$  (pos. 7) from accessories. Place tow-ball (pos. 2) according to supplied instruction.
- Fix the socket plate (pos. 3) as shown on the drawing.
- Connect electric wires of 7-poles socket according to the instruction of the car. (Recommend to make at authorized service station)
- Complete the paint coating damaged during installation.

Torque settings for nuts and bolts (8,8):

<b>M6</b> - 11 Nm	<b>M 8</b> - 25 Nm	<b>M 10</b> - 50 Nm
<b>M 12</b> - 87 Nm	<b>M 14</b> - 138 Nm	<b>M16</b> - 210 Nm











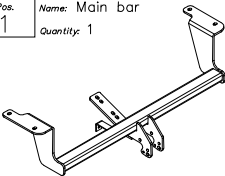







### NOTE

After install the towing hitch you should get adequate registration in registration book (at authorised service station).The car should be equipped with:

- Indicators
- Tow mirrors

After 1000km check all bolts and nuts. The ball of towing hitch must be always kept clear and conserve with a grease.

## Towing hitch accessories:

Pos. 1 Name: Main bar Quantity: 1	Pos. 5 Name: Distance sleeve Quantity: 4	Pos. 10 Name: Body of the automat Quantity: 1	Pos. 15 Name: Spring washer Quantity: 6 Dim.: $\varnothing$ 10,2 mm
			
Pos. 2 Name: Tow-ball Quantity: 1	Pos. 6 Name: Washer Quantity: 4 Dim.: $\varnothing$ 35x $\varnothing$ 12x3mm	Pos. 11 Name: Nut 8 B Quantity: 4 Dim.: M10	Pos. 16 Name: Bolt 8,8 B Quantity: 1 Dim.: M8x30mm
			
Pos. 3 Name: Socket plate Quantity: 1	Pos. 7 Name: Bolt 8,8 B Quantity: 4 Dim.: M12x25mm	Pos. 12 Name: Plain washer Quantity: 4 Dim.: $\varnothing$ 13 mm	Pos. 17 Name: Plain washer Quantity: 2 Dim.: $\varnothing$ 8,5 mm
			
Pos. 4 Name: Ball cover Quantity: 1	Pos. 8 Name: Bolt 8,8 B Quantity: 4 Dim.: M10x90 mm	Pos. 13 Name: Plain washer Quantity: 6 Dim.: $\varnothing$ 10,5 mm	Pos. 18 Name: Nut 8 B Quantity: 1 Dim.: M8
			
	Pos. 9 Name: Bolt 8,8 B Quantity: 2 Dim.: M10x35 mm	Pos. 14 Name: Spring washer Quantity: 4 Dim.: $\varnothing$ 12,2 mm	Pos. 19 Name: Spring Quantity: 1
			



**PPUH AUTO-HAK S. J.**

Produkcja Zaczepów Kulowych  
Henryk & Zbigniew Nejman  
76-200 SŁUPSK ul. Słoneczna 16K  
tel/fax (059) 8-414-414; 8-414-413  
E-mail: [office@autohak.com.pl](mailto:office@autohak.com.pl)  
[www.autohak.com.pl](http://www.autohak.com.pl)

## Towing hitch (without electrical set)

Class: **A50-X** Cat. no. **W19A**

Designed for:

Manufacturer: **SUZUKI**

Model: **IGNIS**

Type: **3/5 doors**

produced since 04.2003 (in Hungary)

Technical data:

**D-value: 5,1 kN**

maximum trailer weight: **800 kg**

maximum vertical cup load: **50 kg**

**Approval number acc. to regulations EKG/ONZ 55.01: E20-55R-01 1251**

### Foreword

This towing hitch is designed according to rules of safety traffic regulations. The towing hitch is a safety component and must be installed only by qualified personnel. Any alteration or conversion to the towing hitch is prohibited and would lead to cancellation of design certification. Remove insulating compound and underseal from vehicle (if present) in the area of the matting surfaces of the towing hitch.

The vehicle manufacturer's specifications regarding trailer load and max. vertical cup load are decisive for driving, and values for the towing hitch must not be exceeded.

*D-value formula:*

$$\frac{\text{Max trailer weight [kg]} \times \text{Max vehicle weight [kg]}}{\text{Max trailer weight [kg]} + \text{Max vehicle weight [kg]}} \times \frac{9,81}{1000} = D \text{ [kN]}$$