

FITTING INSTRUCTION

Clamp mark in acc. with		Cables joining
ISO	PN	
1	L	Left directional lights
2	+	Rear fog lights
3	31	Ground
4	R	Right directional lights
5	58R	Right side parking lights
6	54	Stoplights
7	58L	Left side parking lights

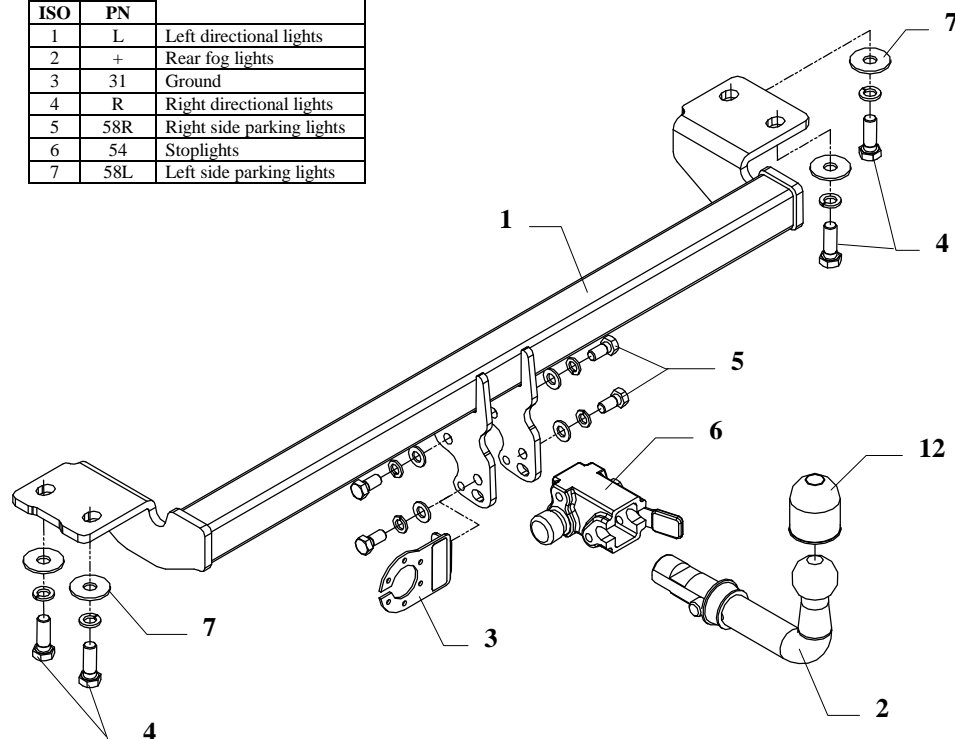

This towbar is designed to assembly in following cars:
TOYOTA AVENSIS ESTATE, produced since 02.1998 till 03.2003,
 catalogue no. **O20A** and is prepared to tow trailers max total weight **1575kg**
 and max vertical mass **75kg**.

From manufacturer

Thank you for buying our product. Their reliability has been confirmed in many tests. Reliability of towbar depends also on correct assembly and right operation. For this reasons we kindly ask to read carefully this instruction and apply to hints.

The towbar should be installing in points described by a car producer.

The instruction of the assembly

1. Disassemble bumper.
2. Disassemble original tow eyes (not used any more).
3. Put main bar of towbar (pos. 1) to chassis and screw it in points remaining after disassembled tow eyes, use bolts M14x1.5x40mm (pos. 4) and washers (pos. 7 and 9).
4. Assemble bumper after cut his fragment (use enclosed template).
5. Fix body of the automat (pos. 6) and the socket plate (pos. 3) using bolts M12x25mm (pos. 4) from accessories. Place tow-ball (pos. 2) according to supplied instruction.
6. Connect electric wires of 7-poles socket according to the instruction of the car. (Recommend to make at authorized service station).
7. Complete paint layer damaged during installation.

Torque settings for nuts and bolts (8,8):

M8	25 Nm	M10	55 Nm
M12	85 Nm	M14	135 Nm









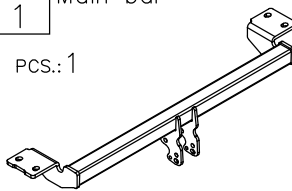
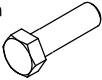

NOTE

After install the towbar you should get adequate note in registration book (at authorised service station).The car should be equipped with:

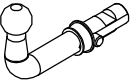
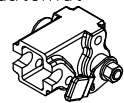
- Indicators
- Tow mirrors

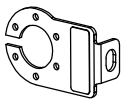
After 1000km of exploitation check all bolts and nuts. The ball of towbar must be always kept clear and conserve with a grease.

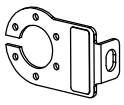
Towbar accessories:

Pos. 1	Main bar 	PCS.: 1
Pos. 4	Bolt 8,8 B M14x1,5x40mm 	PCS.: 4
Pos. 5	Bolt 8,8 B M12x25mm 	PCS.: 4
Pos. 8	Plain washer Ø12mm 	PCS.: 4
Pos. 9	Spring washer Ø14,2mm 	PCS.: 4
Pos. 2	Tow ball 	PCS.: 1
Pos. 6	Body of the automat 	PCS.: 1
Pos. 10	Spring washer Ø12,2mm 	PCS.: 4
Pos. 3	Socket plate 	PCS.: 1
Pos. 7	Plain washer Ø44xØ15x3mm 	PCS.: 4
Pos. 11	Body plug 	PCS.: 1
Pos. 12	Ball cover 	PCS.: 1



PPUH AUTO-HAK S.J.

Produkcja Zaczepów Kulowych
Henryk & Zbigniew Nejman
76-200 SŁUPSK ul. Słoneczna 16K
tel/fax (059) 8-414-414; 8-414-413
E-mail: office@autohak.com.pl
www.autohak.com.pl

Towing hitch (without electrical set)

Class: **A50-X** Cat. no. **O20A**

Designed for:

Manufacturer: **TOYOTA**

Model: **AVENSIS**

Type: **ESTATE**

produced since 02.1998 till 03.2003

Technical data:

D-value: 8,3 kN

maximum trailer weight: **1575 kg**

maximum vertical cup mass: **75 kg**

Approval number acc. to regulations EKG/ONZ 55.01: **E20-55R-01 1342**

Foreword

This towbar is designed according to rules of safety traffic regulations. The towing hitch is a safety component and can be install only by qualified personnel. Any alteration or conversion of the towing hitch is prohibited and would lead to cancellation of design certification. Remove insulating compound and underseal from vehicle (if present) in the area of the matting surfaces of the towing hitch.

The vehicle manufacturer's specifications regarding trailer load and max. vertical cup load are decisive for driving, and values for the towing hitch cannot be exceeded.

D-value formula:

$$\frac{\text{Max trailer weight [kg]} \times \text{Max vehicle weight [kg]}}{\text{Max trailer weight [kg]} + \text{Max vehicle weight [kg]}} \times \frac{9,81}{1000} = D \text{ [kN]}$$