

UNIVERSAL E - KIT EXPERT

748350

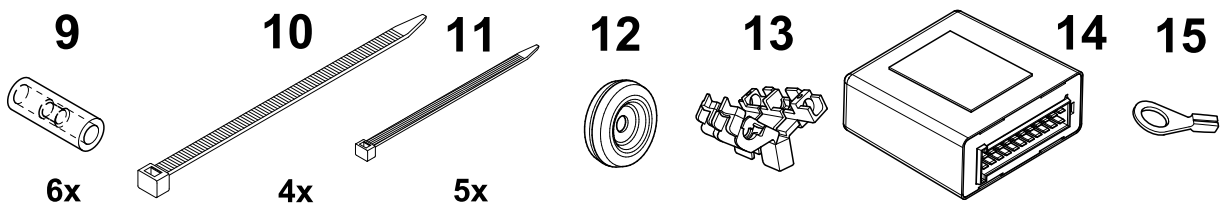

1

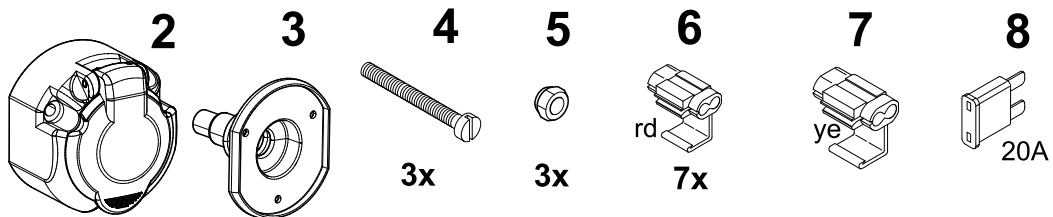
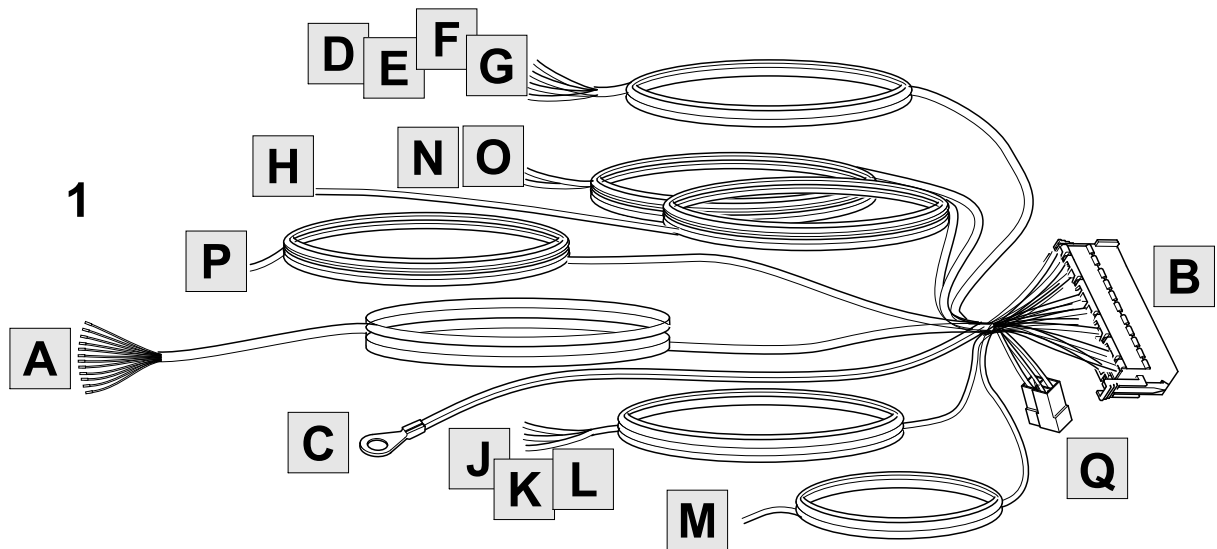
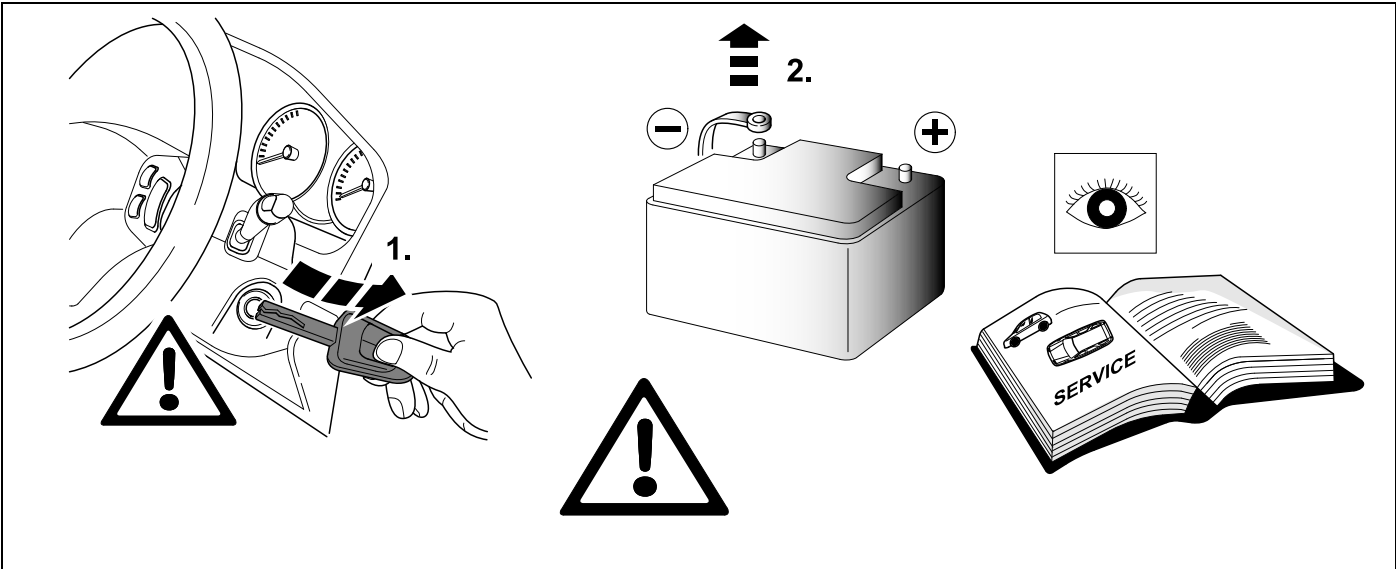

2

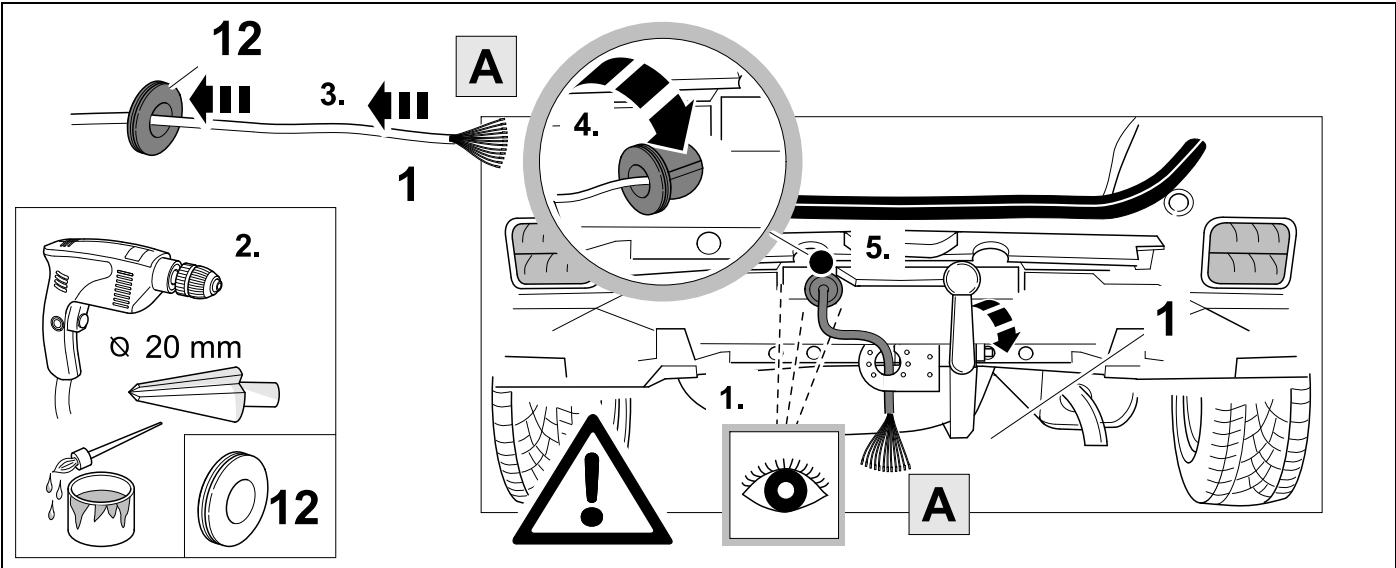

3

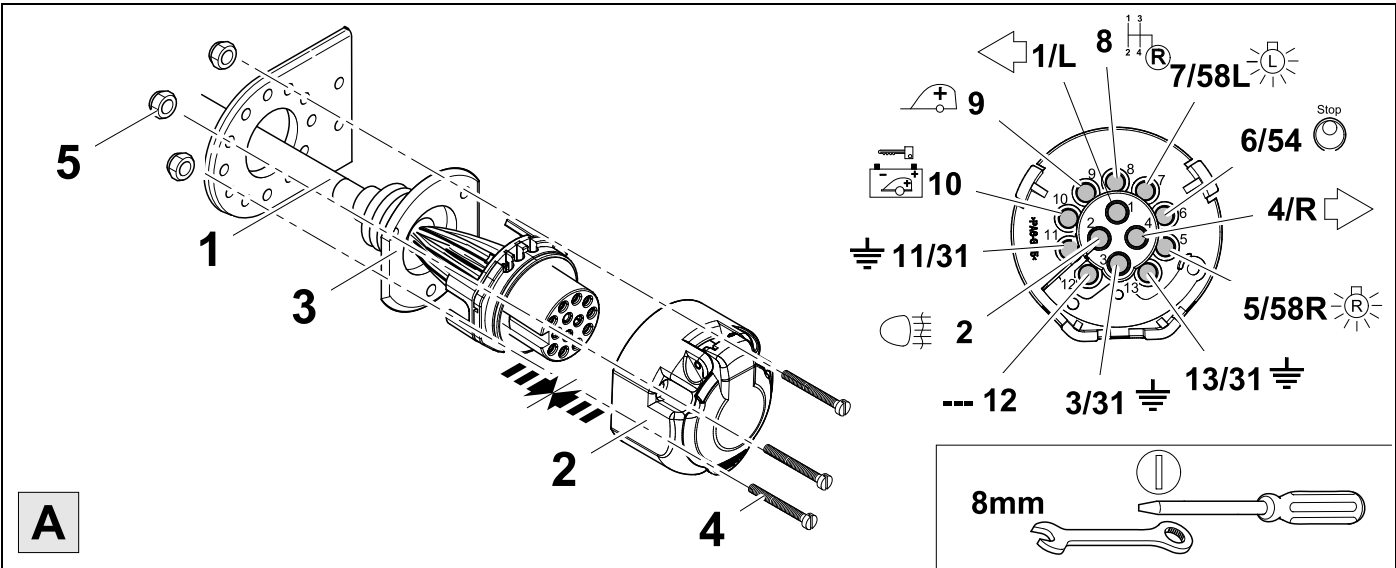

4



5

1	ye		7	bk	
2	bu		8	vi	
3	wh		9	or	
4	gn		10	gy	
5	bn		11	wh/bk	
6	rd		13	wh/rd	

5	bk	wh	gy	gn	rd	bu	ye	bn	vi	or
(D)	schwarz	weiß	grau	grün	rot	blau	gelb	braun	violett	orange
(GB)	black	white	grey	green	red	blue	yellow	brown	purple	orange
(F)	noir	blanc	gris	vert	rouge	bleu	jaune	brun	violet	orange
(NL)	zwart	wit	grijs	groen	rood	blauw	geel	bruin	violet	oranje
(DK)	sort	hvid	grå	grøn	rød	blå	gul	brun	violet	orange
(N)	svart	hvit	grå	grønn	rød	blå	gul	brun	fiolett	oransje
(S)	svart	vit	grå	grön	röd	blå	gul	brun	violett	orange
(FIN)	musta	valkoinen	harmaa	vihreä	punainen	sininen	keltainen	ruskea	violetti	oranssi
(I)	nero	bianco	grigio	verde	rosso	blu	giallo	marrone	viola	arancione
(E)	negro	blanco	gris	verde	rojo	azul	amarillo	marrón	violeta	anaranjado
(P)	preto	branco	cinzento	verde	vermelho	azul	amarelo	castanho	violeta	laranja
(GR)	μαύρος	λευκός	Γκρι	πράσινος	κόκκινος	μπλε	κίτρινος	καφέ	Μωβ	πορτοκαλί
(PL)	czarny	biały	szary	zielony	czerwony	niebiesko	żółty	brazowy	fioletowy	pomarańczowy
(CZ)	černý	bílý	šedý	zelený	červený	modrý	žlutý	hnědý	fialový	oranžový
(TR)	siyah	beyaz	gri	yeşil	kırmızı	mavi	sarı	kahverengi	mor	portakal rengi
(H)	fekete	fehér	szürke	zöld	piros	kék	sárga	barna	ibolyakék	narancssárga
(HR)	crno	bijelo	sivo	zeleno	crveno	plavo	zuto	smeđe	ljubičasto	narandasto
(BUL)	черен	бял	сив	зелен	червен	син	жълт	кафяв	виолетов	оранжев
(RO)	negru	alb	gri	verde	roșu	albastru	galben	maro	violet	portocaliu
(RU)	черный	белый	серый	зеленый	красный	голубой	жёлтый	коричневый	пурпур-ный	оранжевый
(LT)	juoda	balta	pilka	žalia	raudona	mėlyna	geltona	ruda	purpurinė	oranžinė
(LV)	melna	balta	pelēka	zaļa	sarkana	zila	dzeltena	brūna	purpur-sarkana	oranža
(EST)	must	valge	hall	roheline	punane	sinine	kollane	pruun	purpur-punane	oraanž
(SLO)	črna	bela	siva	zelena	rdeča	modra	rumena	smeđ	vijoličast	oranžen
(SK)	čierny	biely	šedý	zelený	červený	modrý	žltý	hnědý	fialový	pomarančový

6

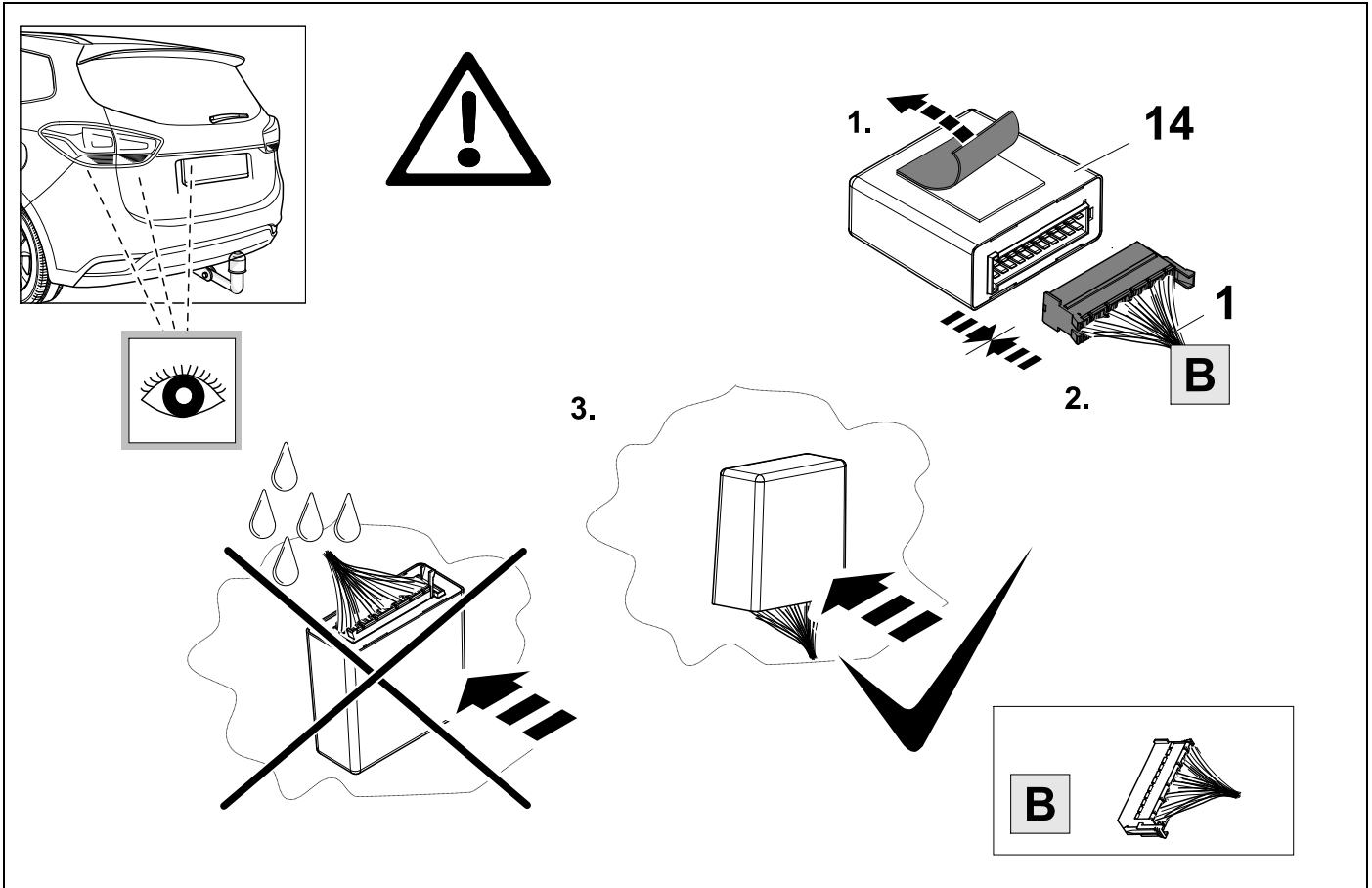

7

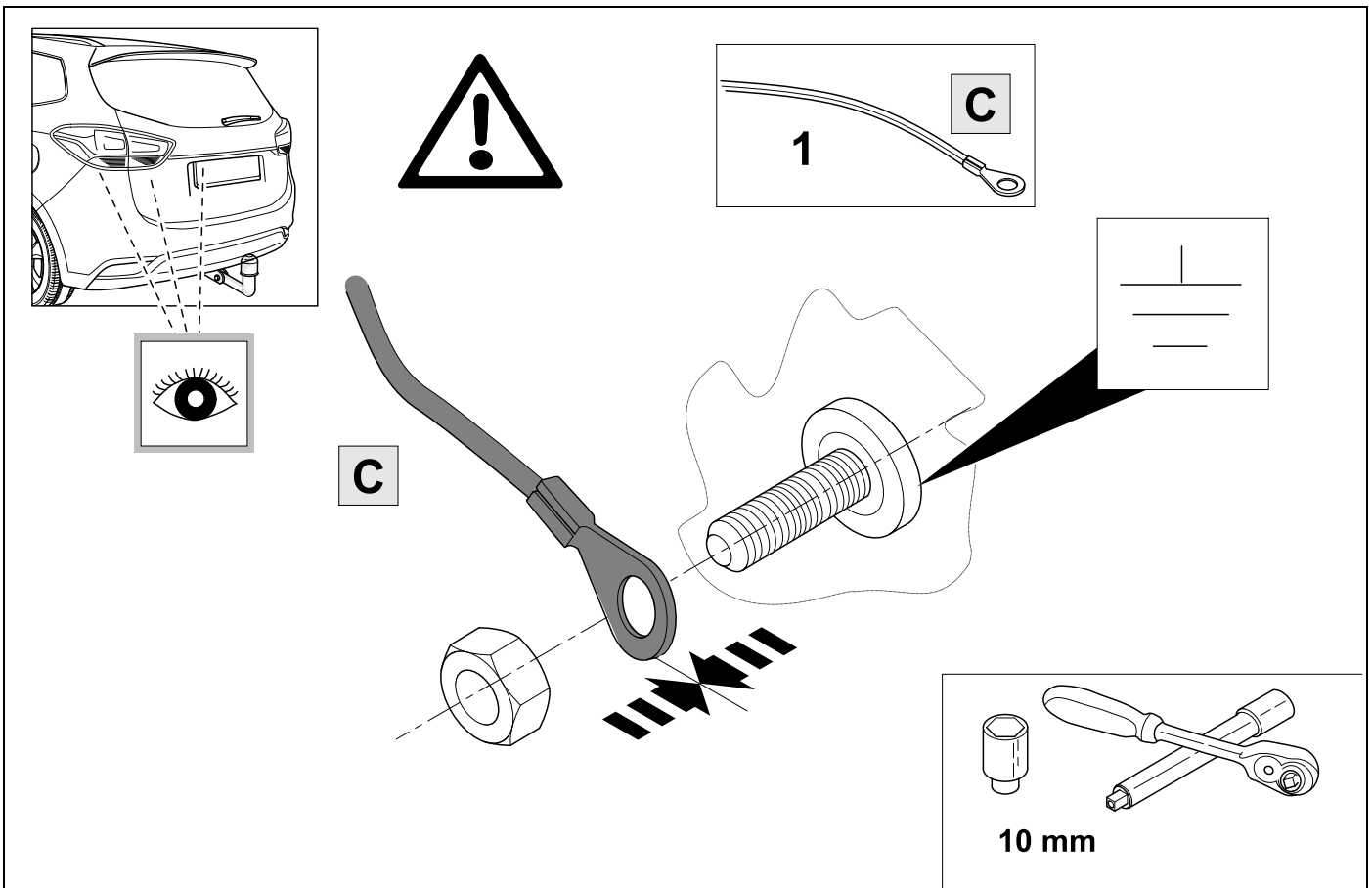

8 TRAILER FLASHER CONTROL FUNCTION

WITHOUT TRAILER FLASHER CONTROL FUNCTION

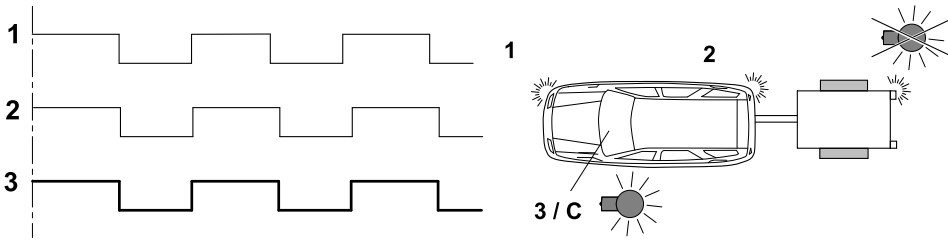

OPTION 1A

9 - 10

13 - 37

WITH TRAILER FLASHER CONTROL FUNCTION

OPTION 1B

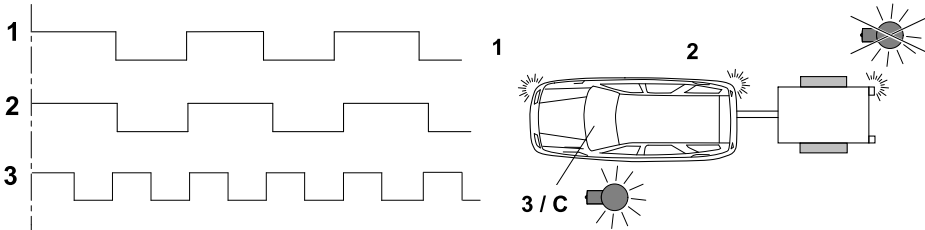

11 - 12

13 - 37

9 WITHOUT TRAILER FLASHER CONTROL FUNCTION

OPTION 1A

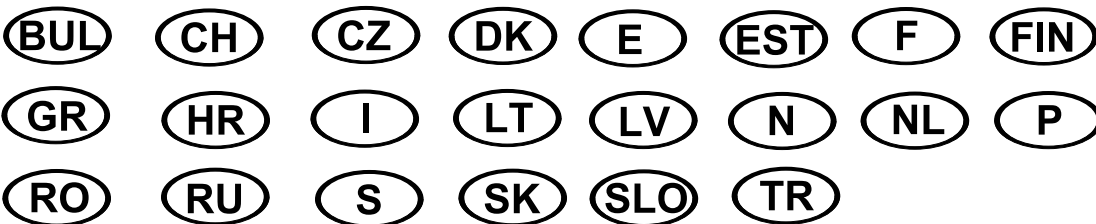
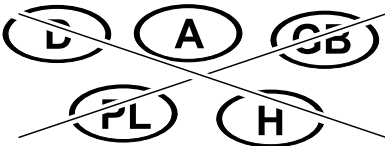
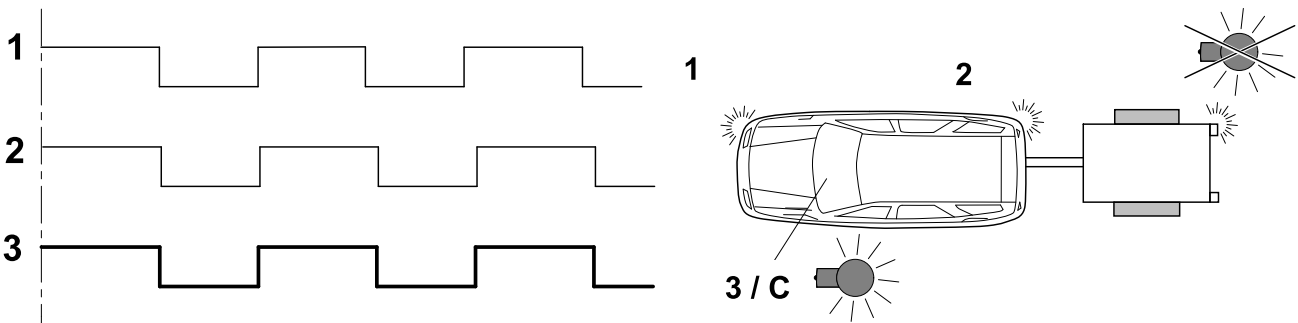

10



5

OPTION 1A

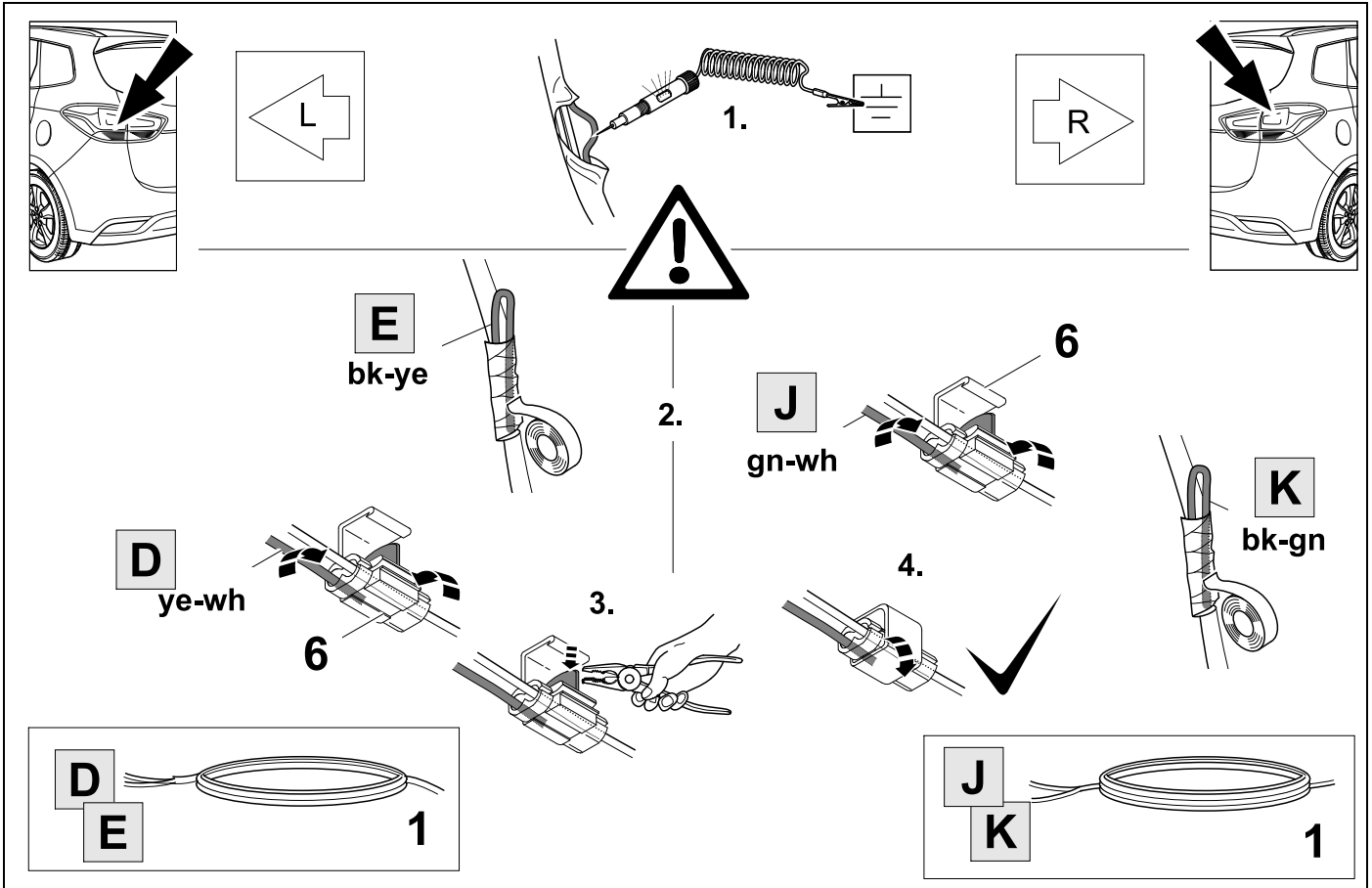

11

WITH TRAILER FLASHER CONTROL FUNCTION

OPTION 1B

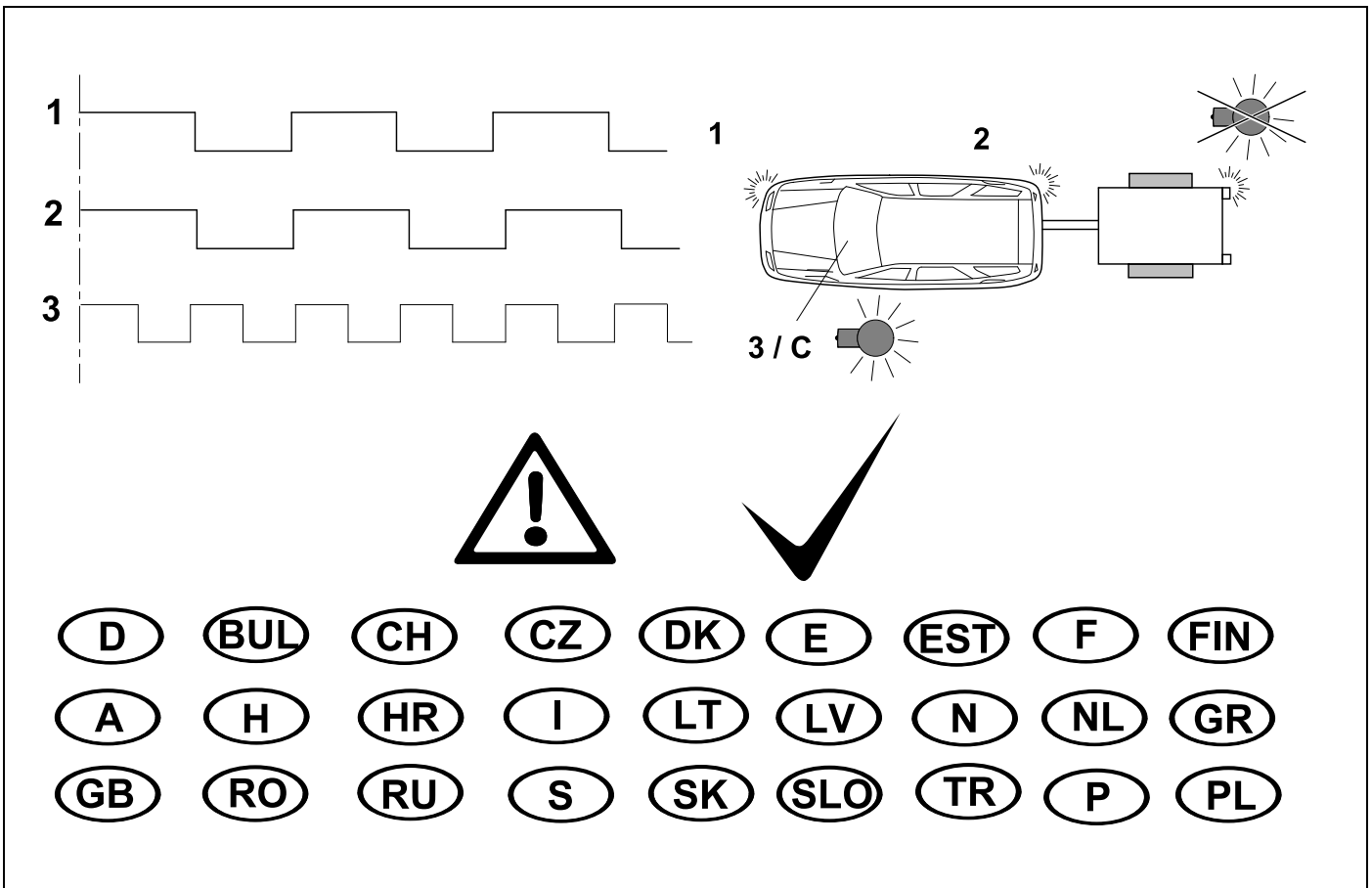

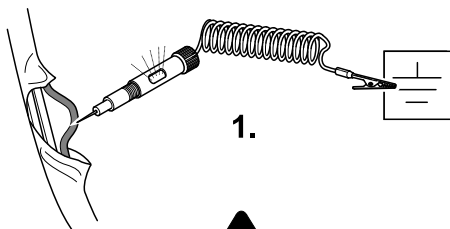
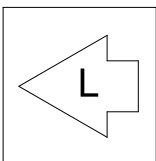
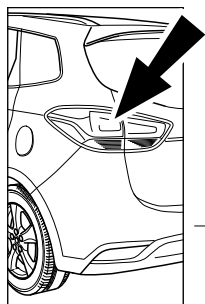

1.

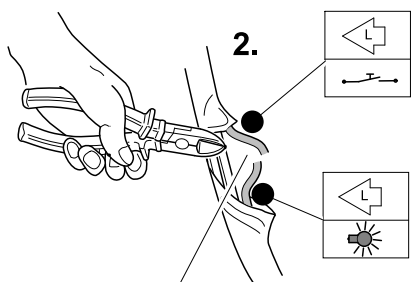
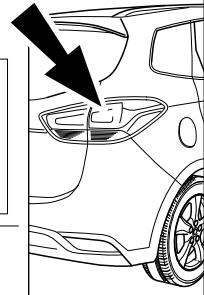
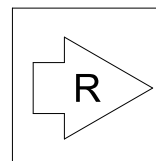

2.

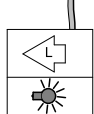
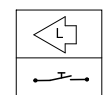

3.

D

ye-wh

4mm

4mm

bk-ye

E

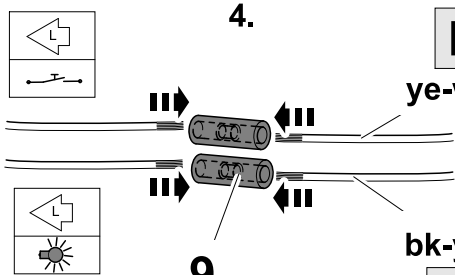

4.

D

ye-wh

9

bk-ye

E

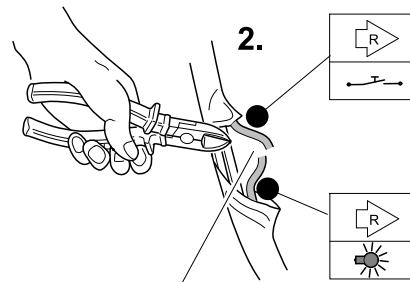

2.

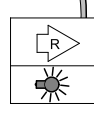
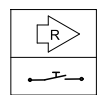

3.

J

gn-wh

4mm

4mm

bk-gn

K

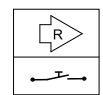

4.

J

gn-wh

9

bk-gn

K

5.

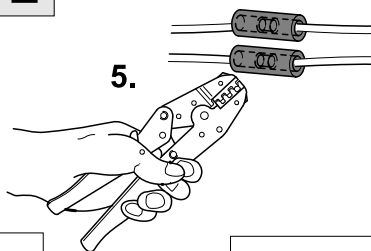

D

E

1

J

K

1

13 MULTIPLEX – SYSTEM / PWM (2 FUNCTIONS IN 1 BULB)

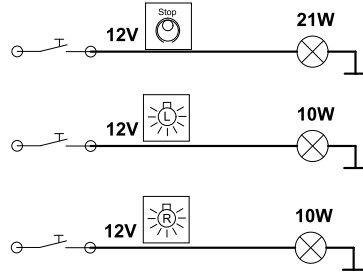
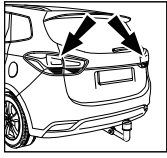

OPTION 2A

14 - 15

18 - 37

WITHOUT MULTIPLEX – SYSTEM / PWM
(1 FUNCTION IN 1 BULB)

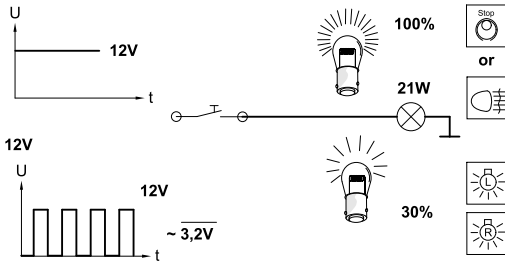
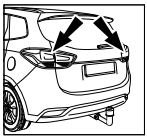

OPTION 2B

16 - 17

18 - 37

WITH MULTIPLEX – SYSTEM / PWM
(2 FUNCTIONS IN 1 BULB)

14 WITHOUT MULTIPLEX – SYSTEM / PWM

(1 FUNCTION IN 1 BULB)

OPTION 2A

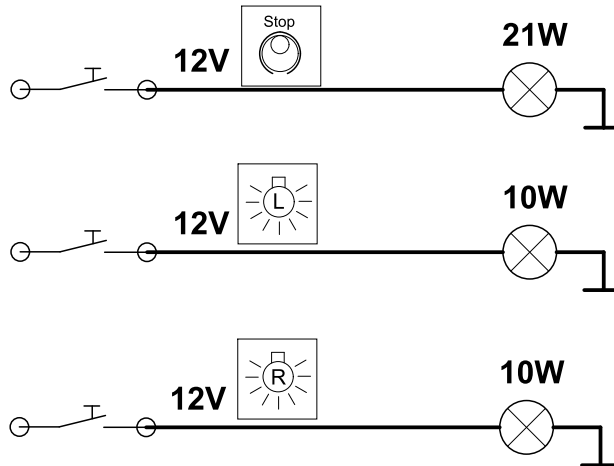
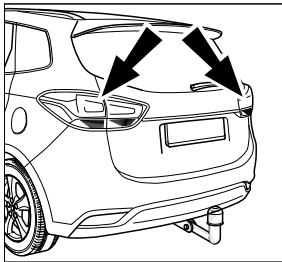

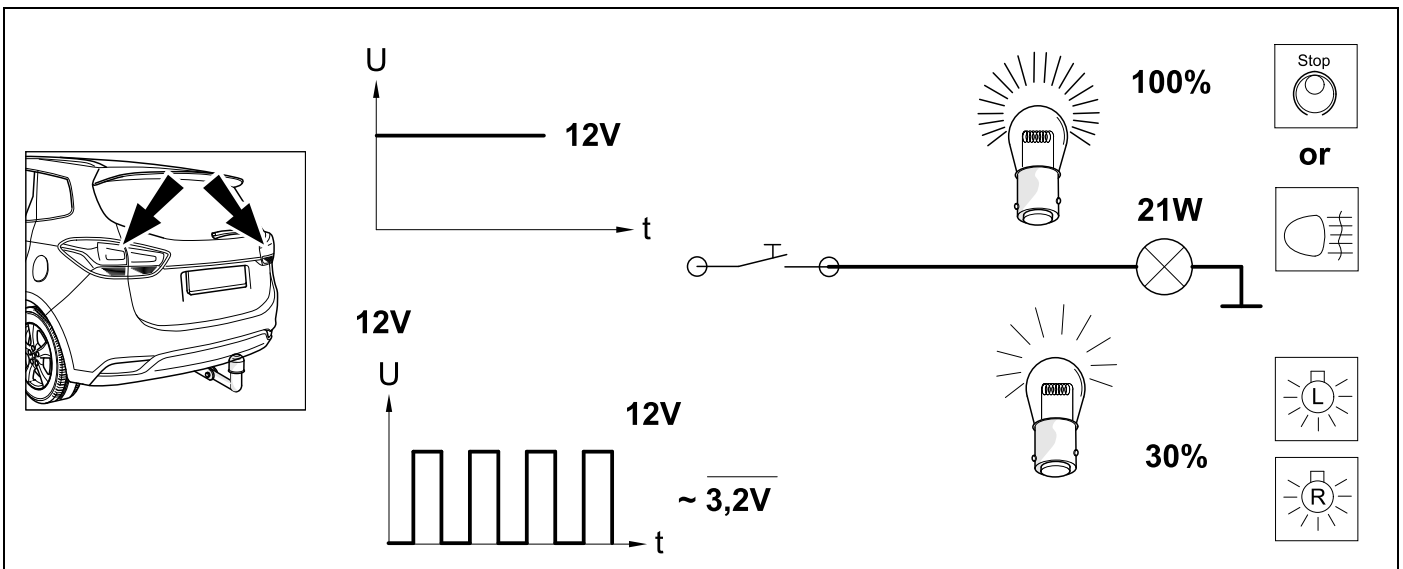
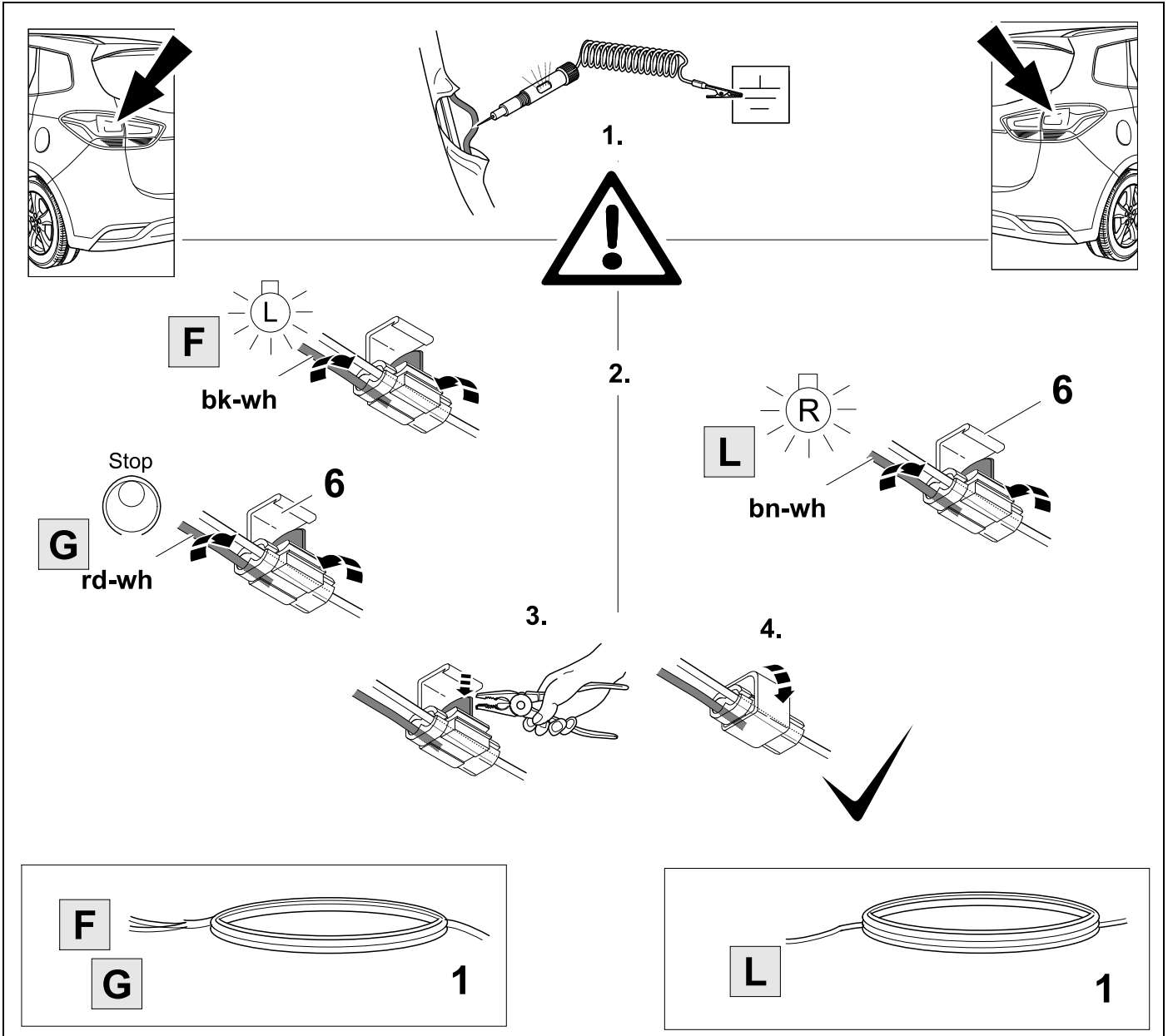

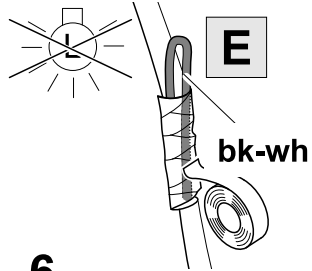
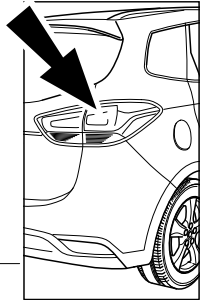
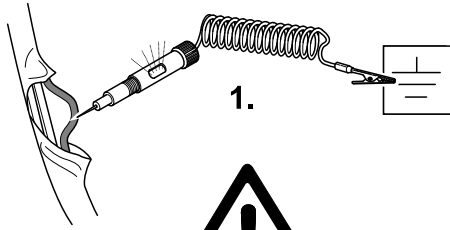
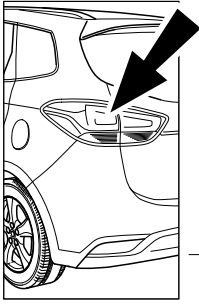

2.

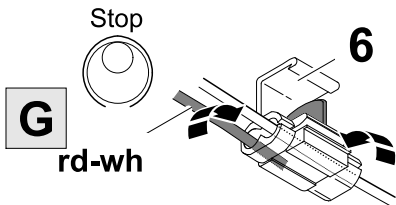
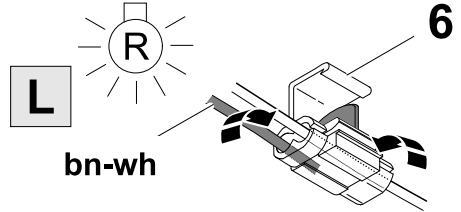

3.

4.

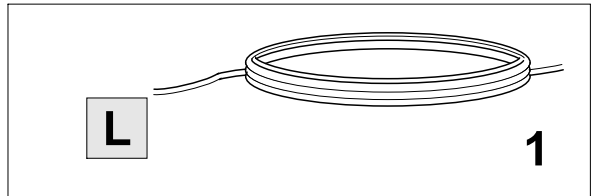
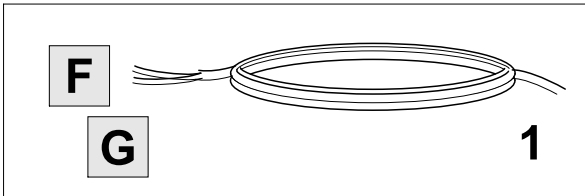
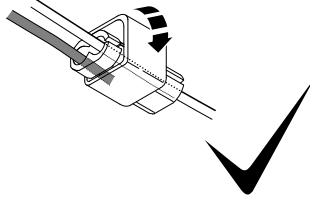
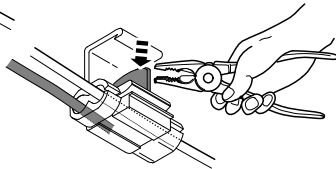

18 POLARITY FOG LAMP (POSITIVE OR NEGATIVE SWITCHED)

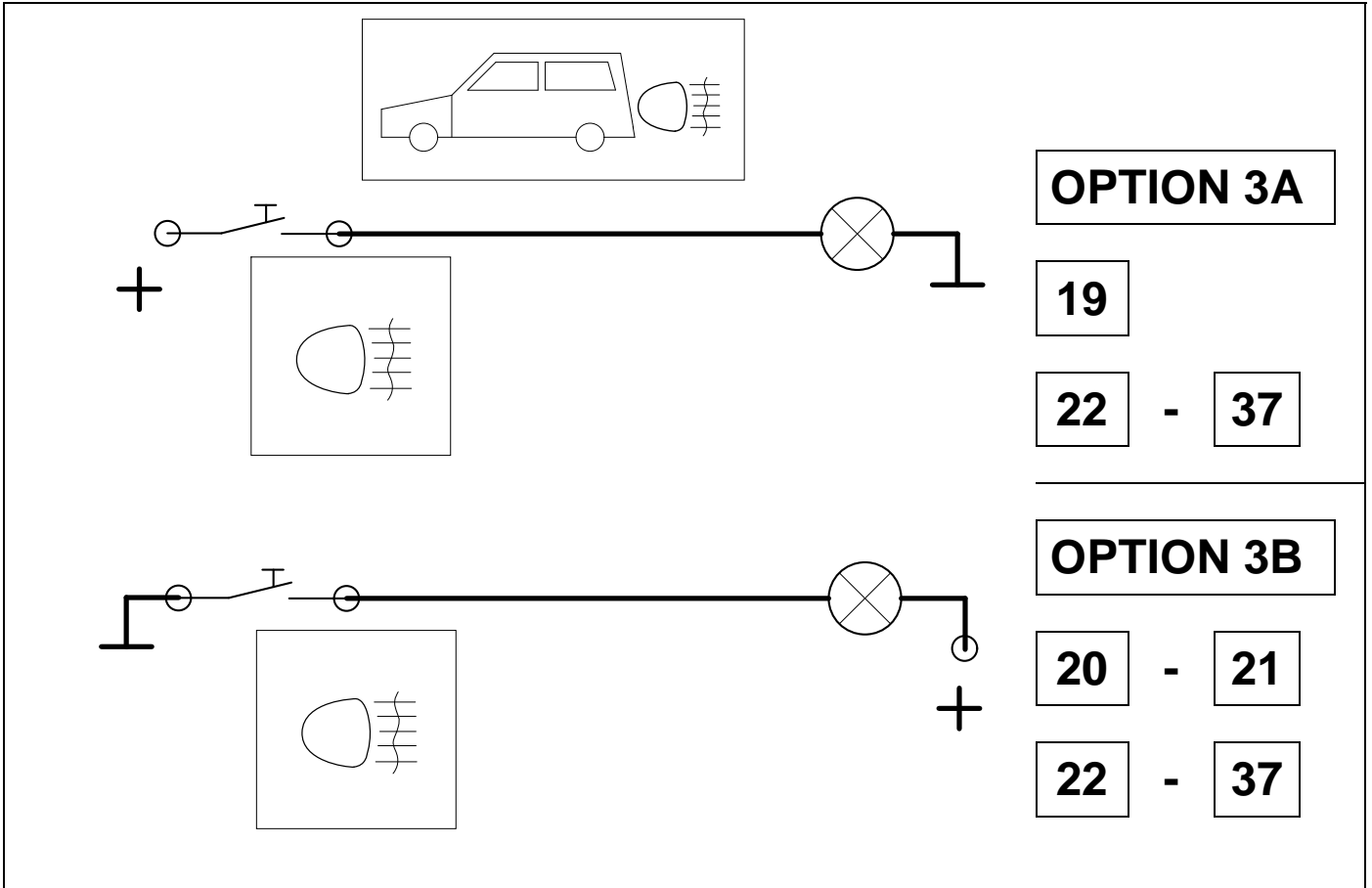

19 POSITIVE SWITCHED



5

OPTION 3A

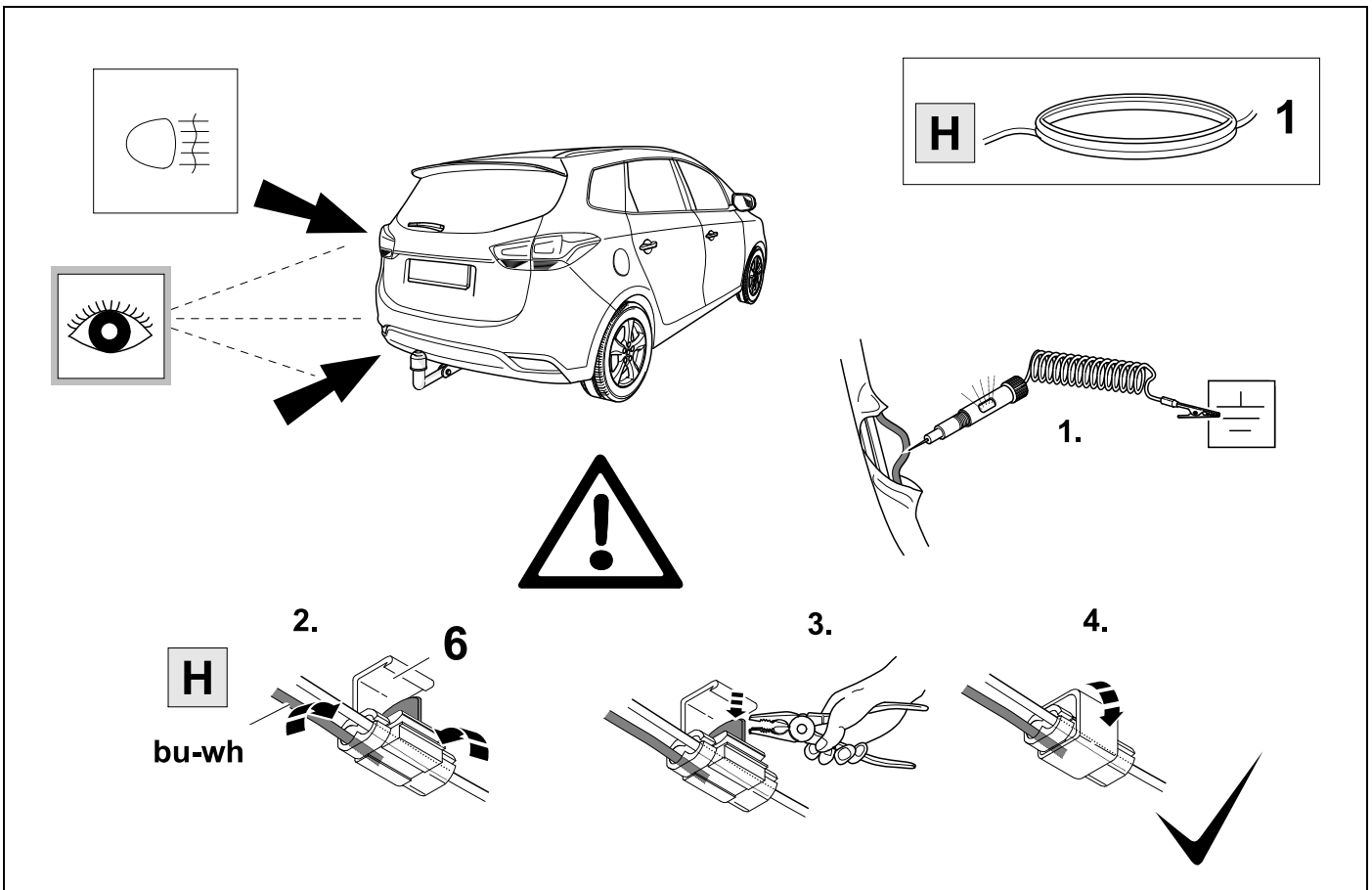

20

NEGATIVE SWITCHED



5

OPTION 3B

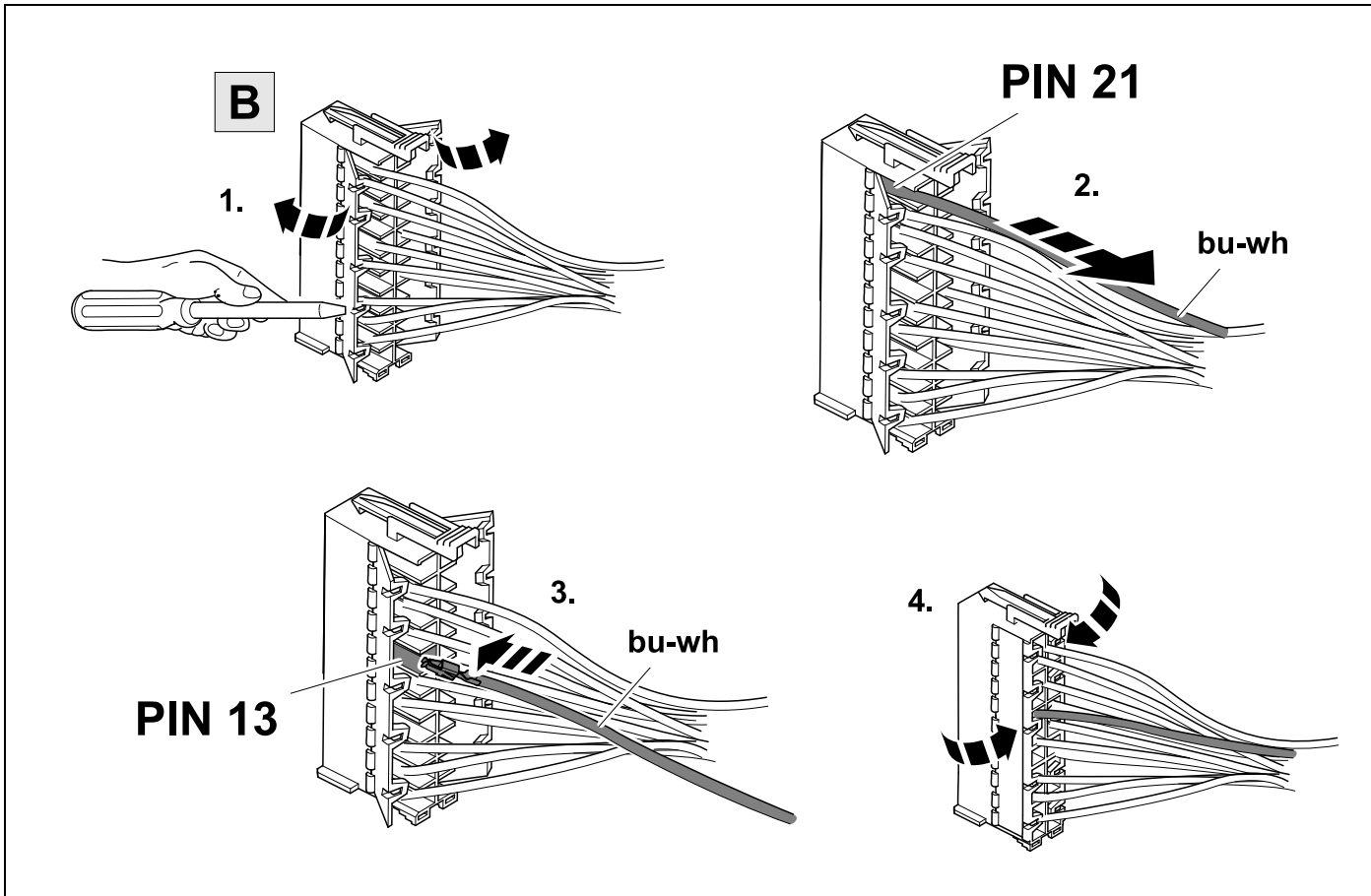

21

NEGATIVE SWITCHED



5

OPTION 3B

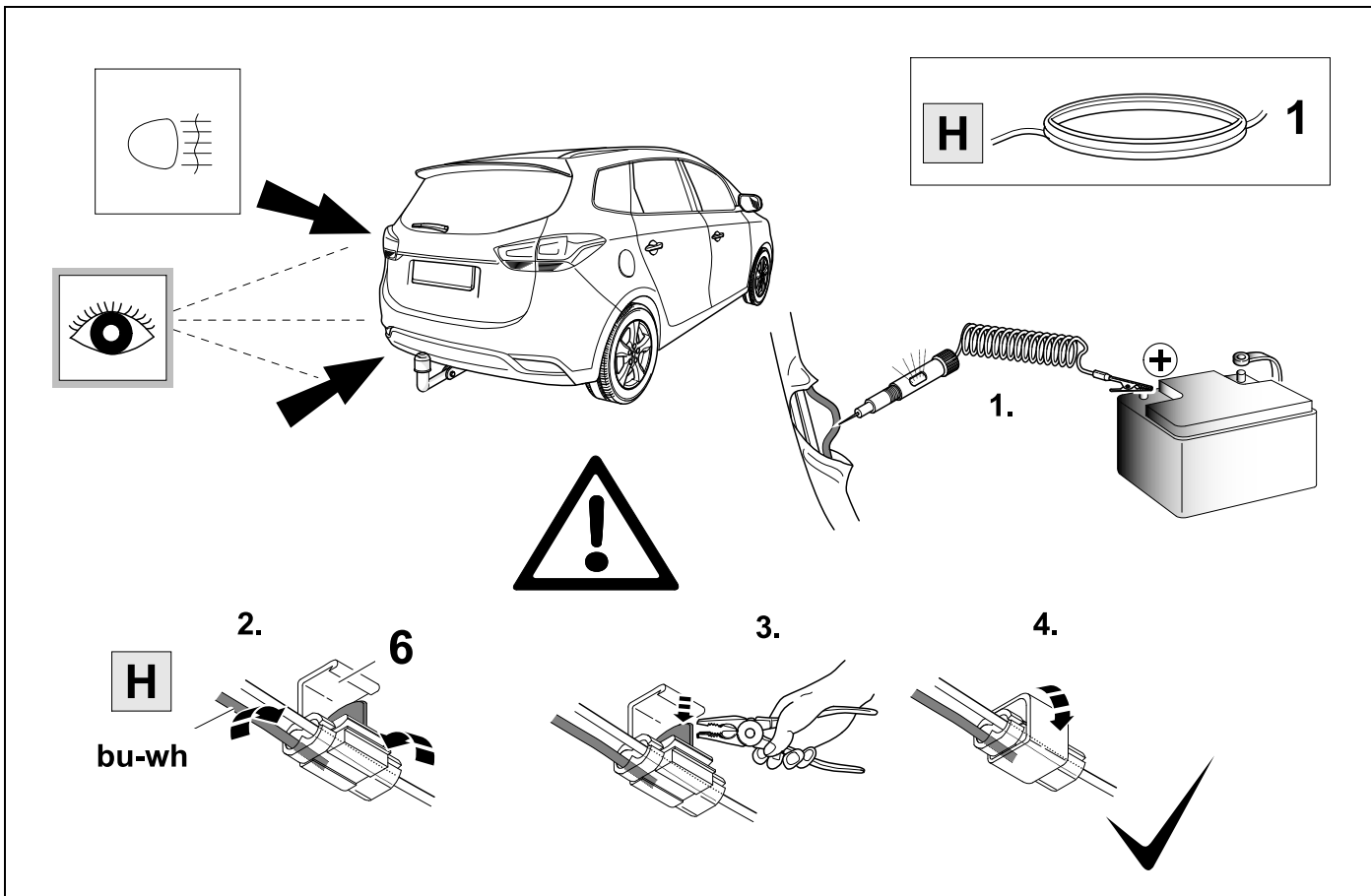

22

👁️ ⇒ 5

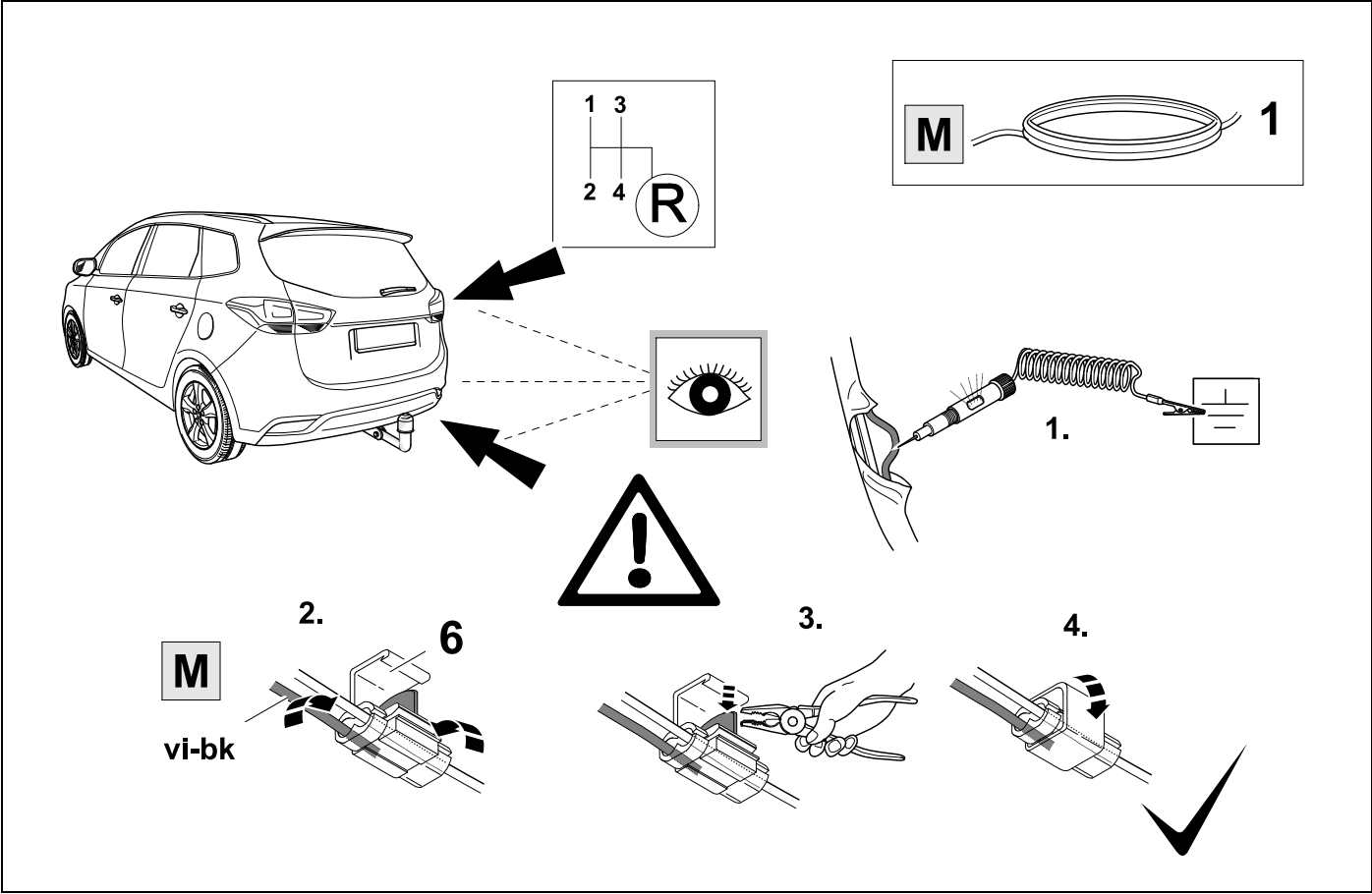

23

👁️ ⇒ 5

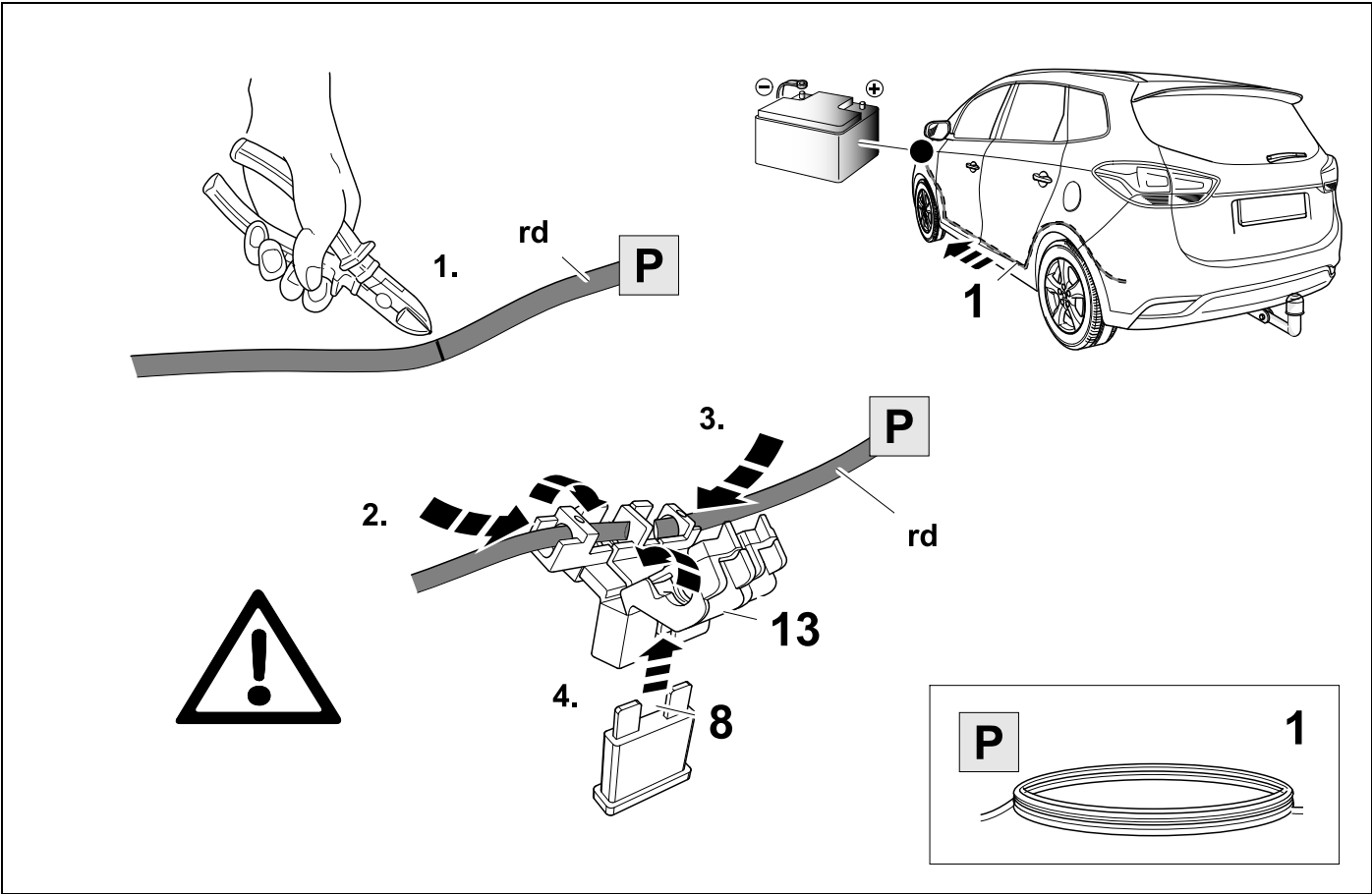

24

OPTION 4A



5

OPTION 4B

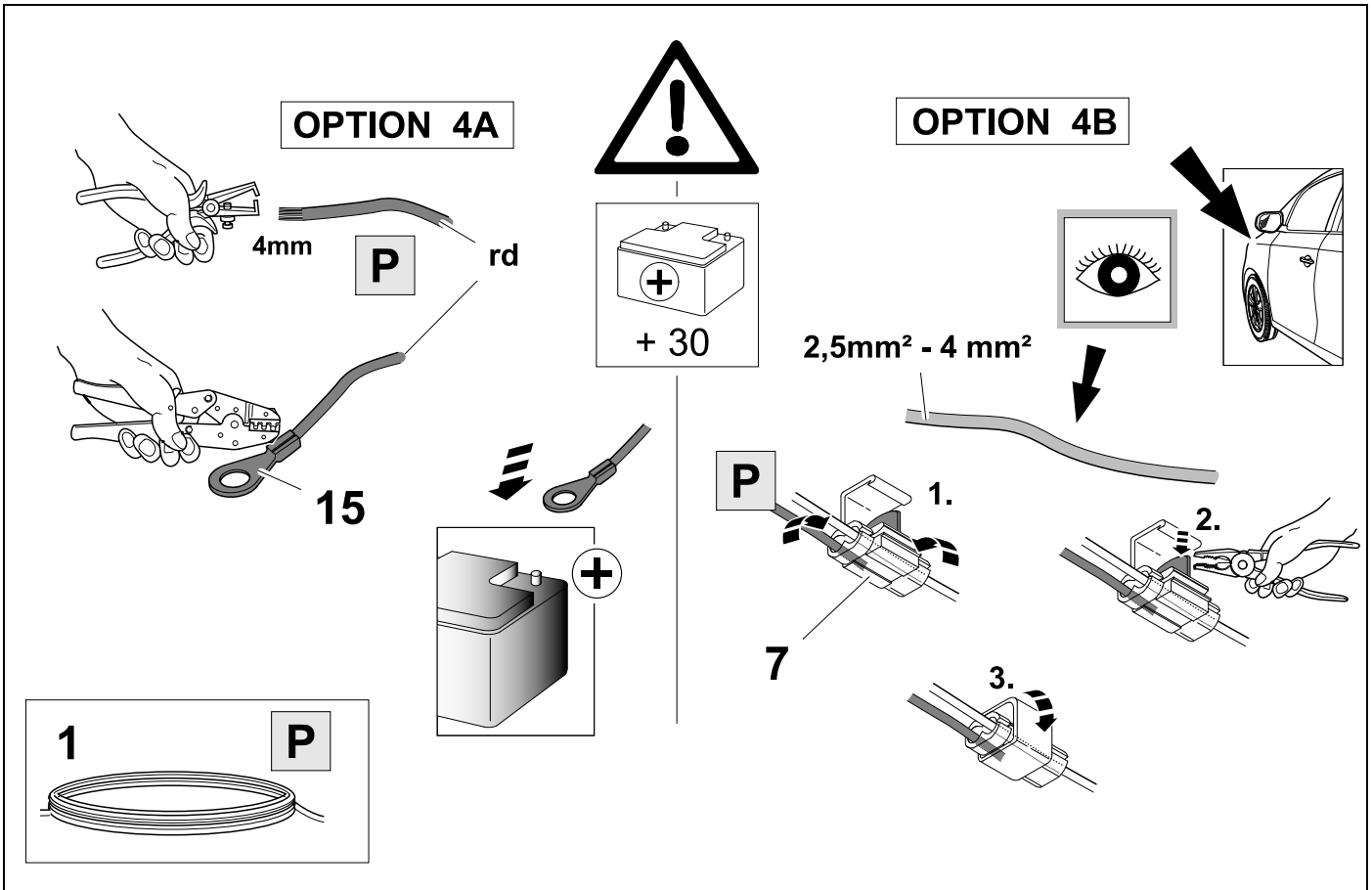

25

PARK DISTANCE CONTROL DEACTIVATION

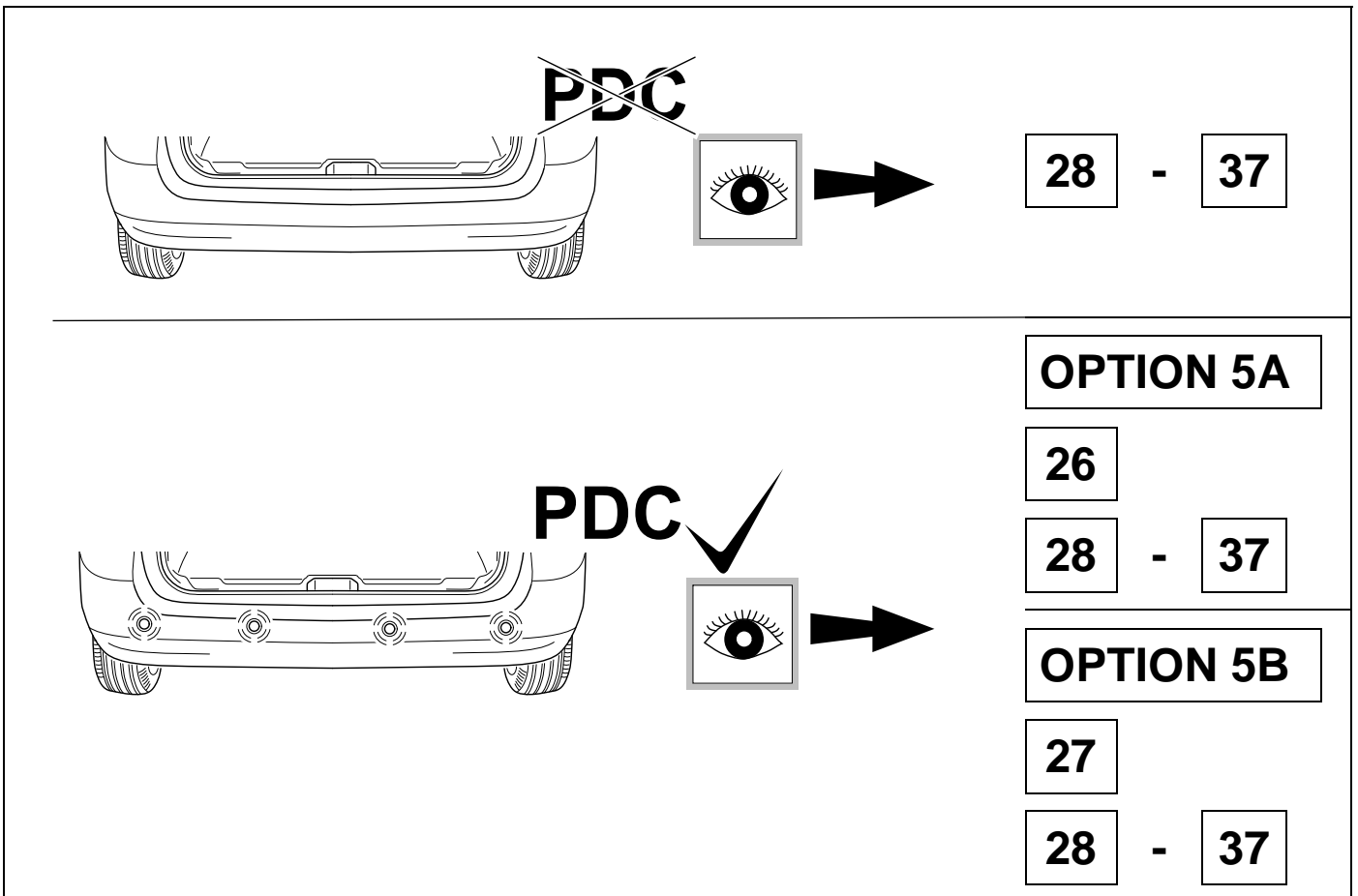

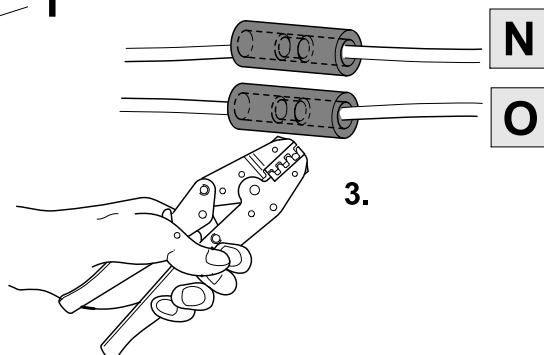
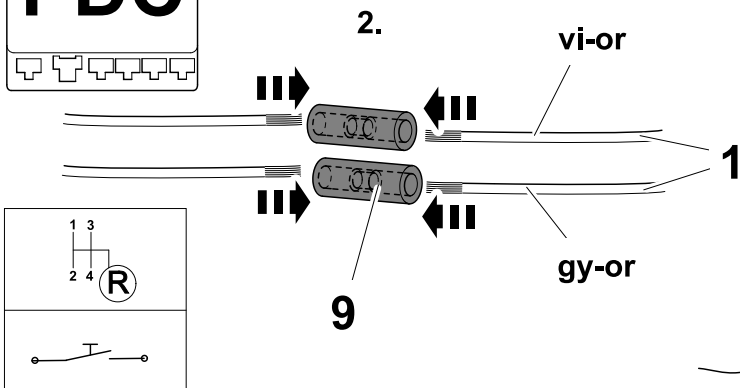
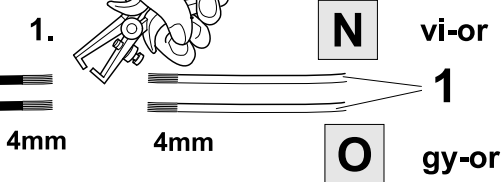
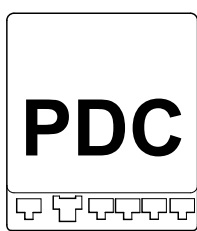
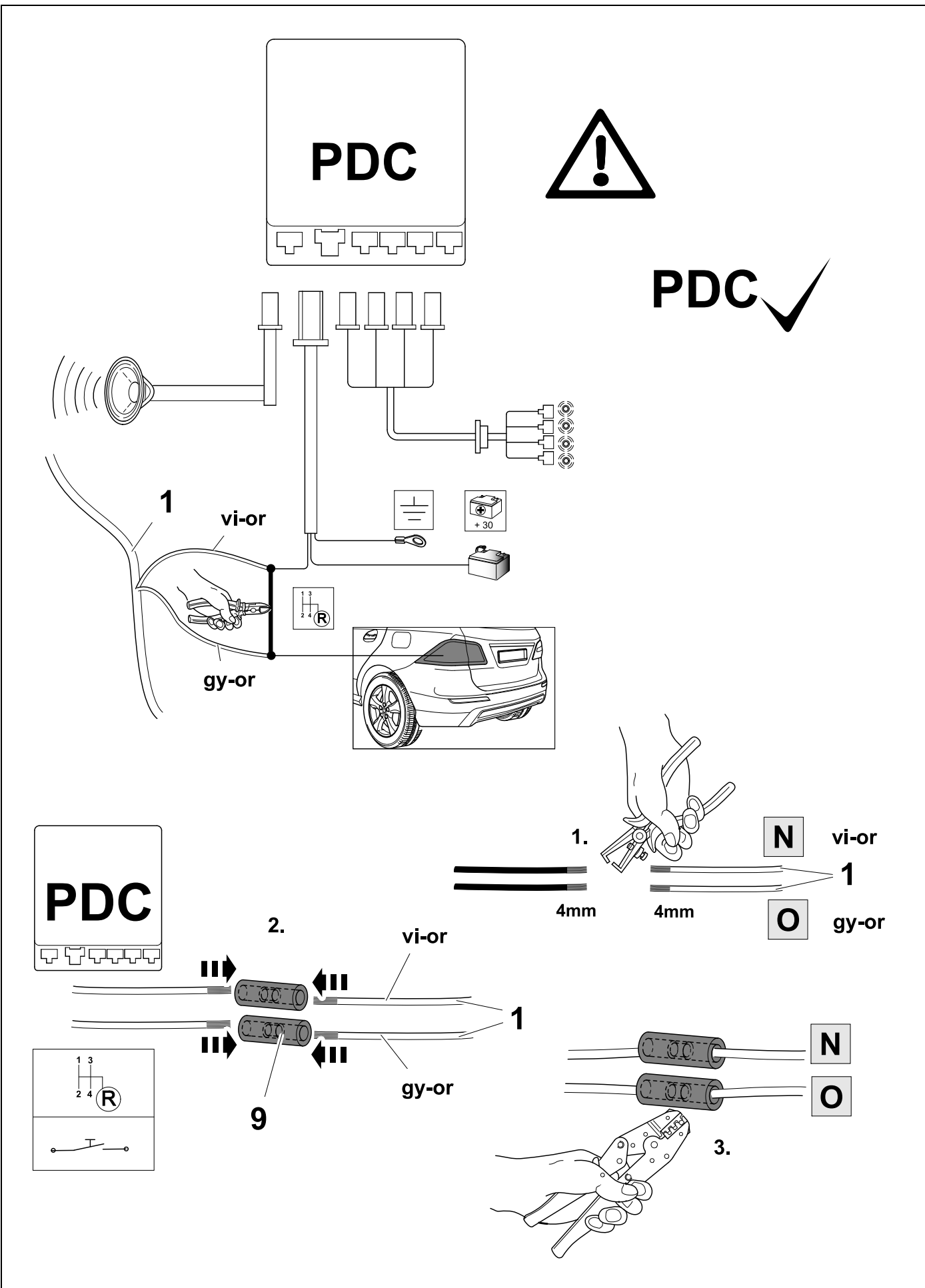

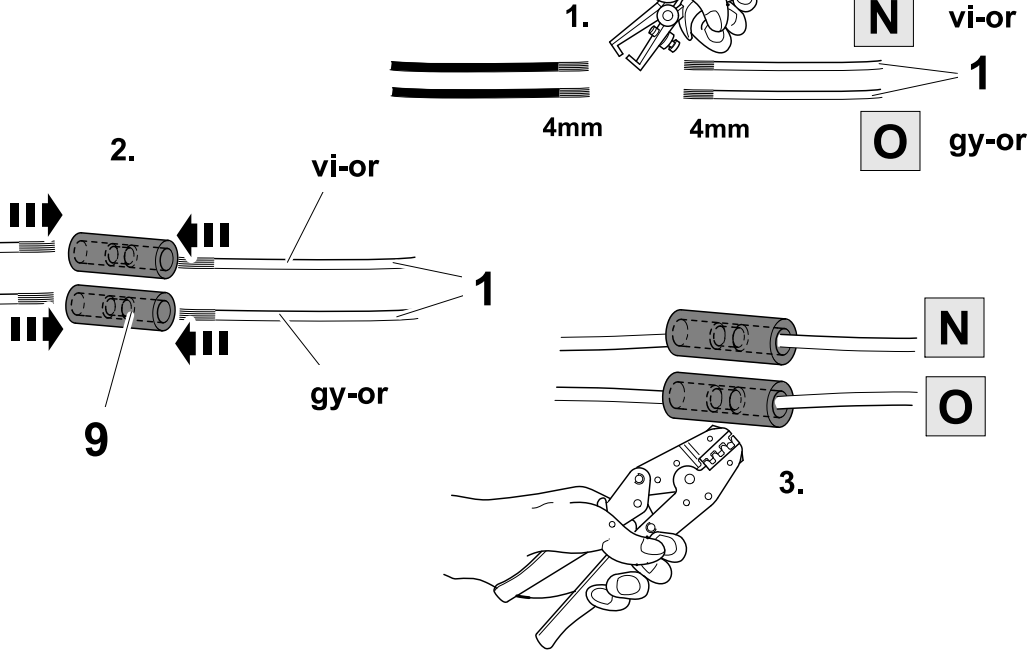
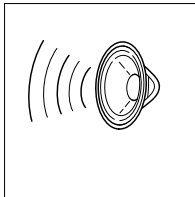
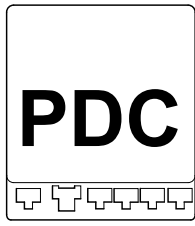
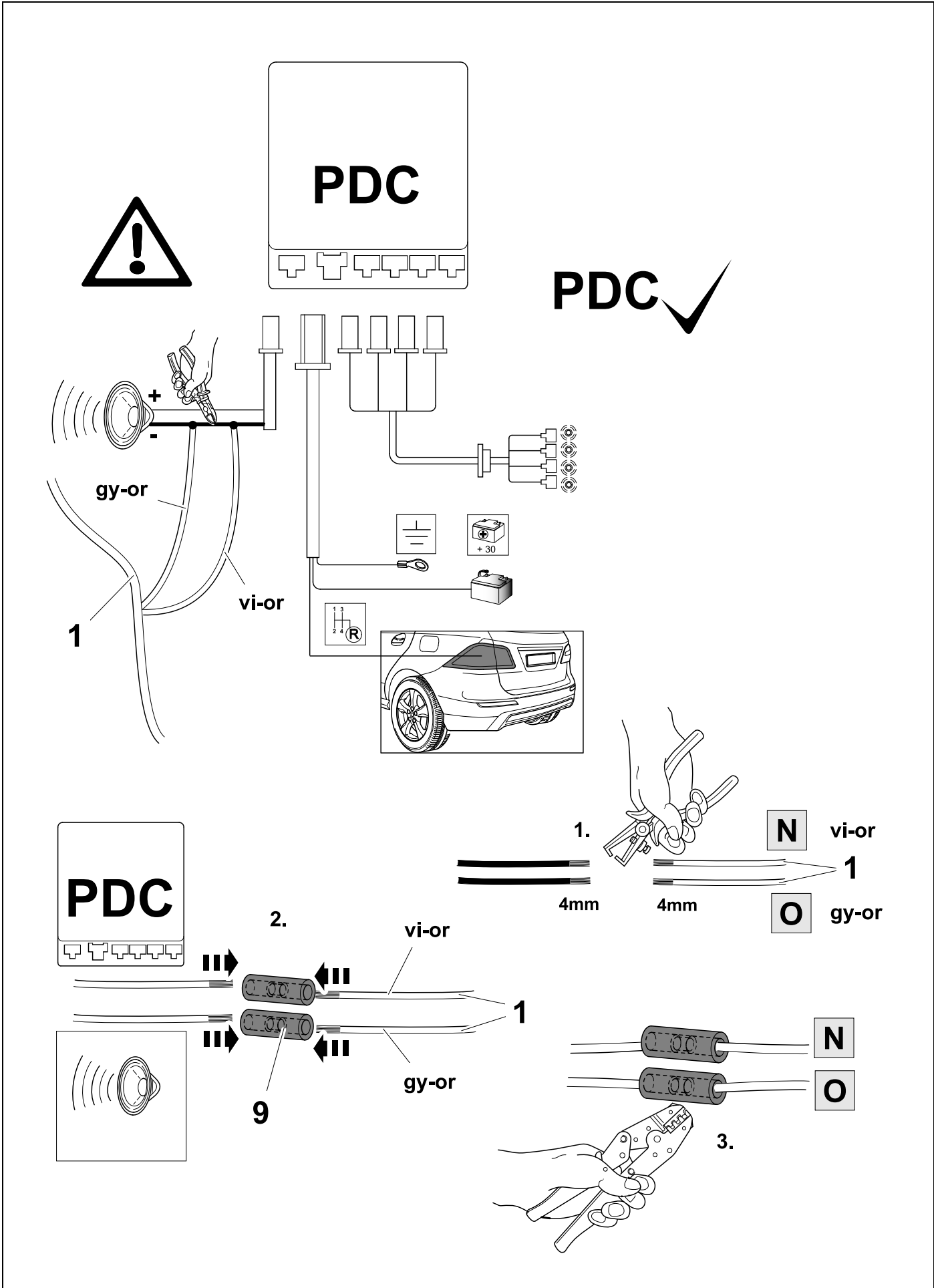

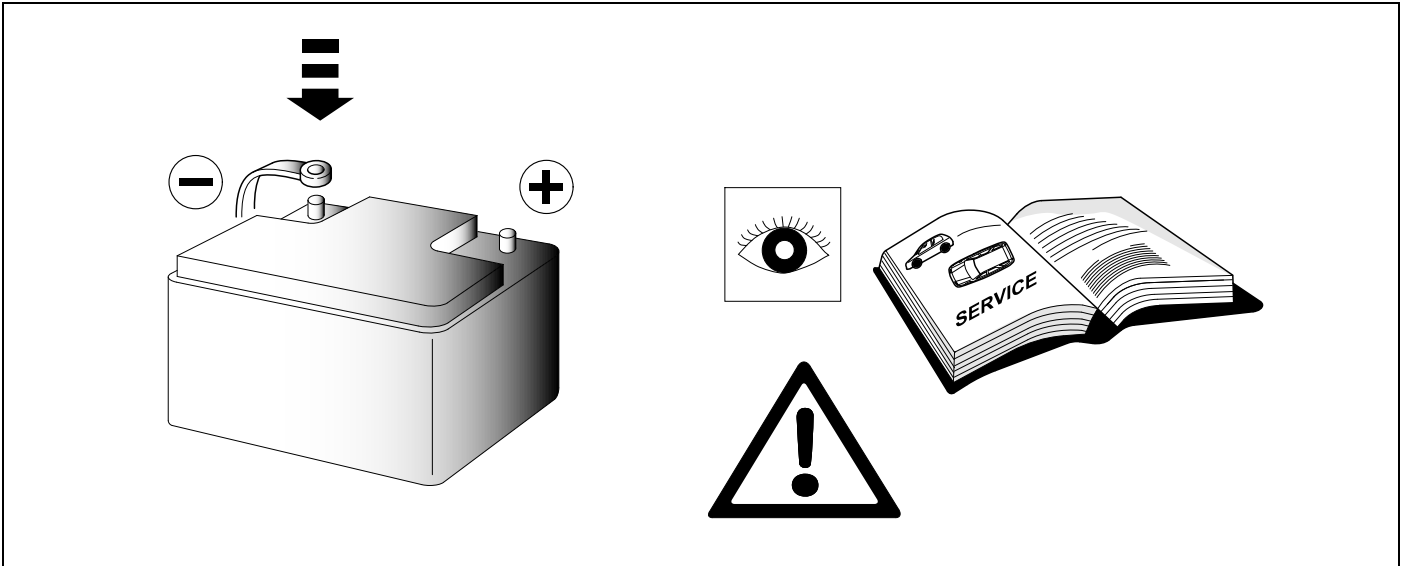

29 OPTIONAL EXTENSION

		Bestellnummer: Order number:	721075

30 OPTIONAL EXTENSION

			Bestellnummer: Order number:	721077

31 CHECK

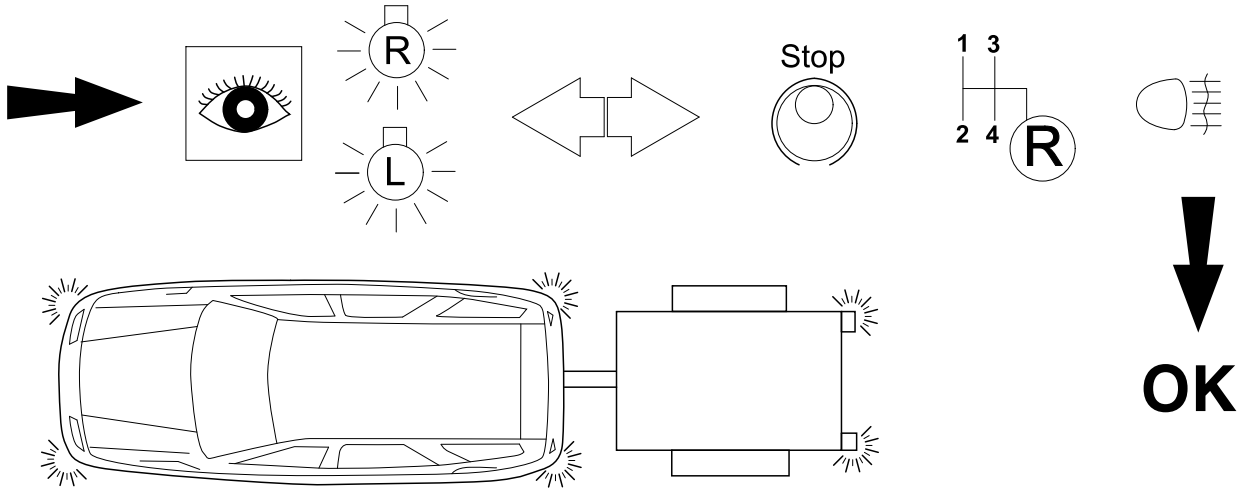

**PLEASE MAKE A PROPER CHECK OF ALL LIGHT FUNCTIONS
BY CONNECTING A TRAILER OR PROPER TESTER
WHICH IMITATES A TRAILER**



IMPORTANT NOTE!

**IN CASE OF FLASHER LIGHT FAILURE ON THE TRAILER,
POSITION LIGHT ON THE TRAILER TAKE OVER FUNCTION
OF FLASHER LIGHT!**



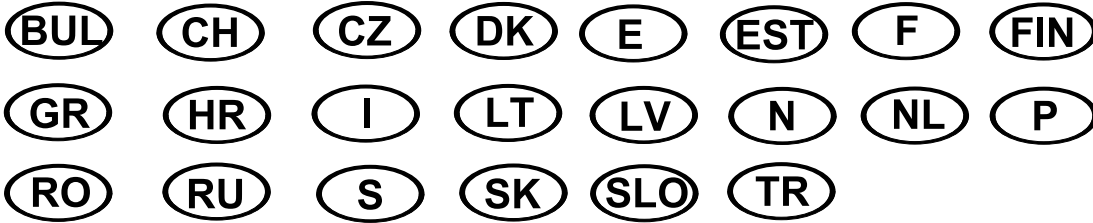
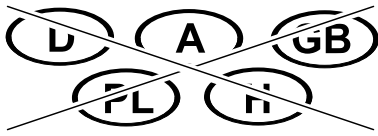

IMPORTANT NOTE!

TRAILER FOG LAMP NOTIFICATION, WHEN THE FOG LAMP ON THE TRAILER IS IN FUNCTION IS NOT STRICTLY REQUIRED!

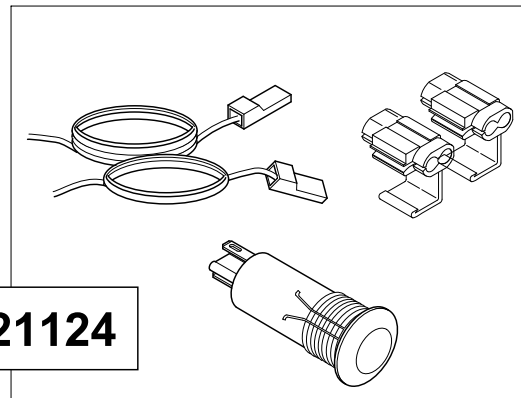
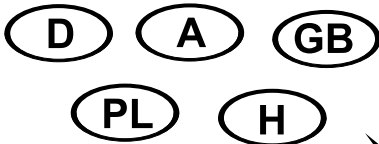

USE EXTENSION KIT 721124

IMPORTANT NOTE!

USE EXTENSION KIT FOR TRAILER FOG LAMP NOTIFICATION, WHEN THE FOG LAMP ON THE TRAILER IS IN FUNCTION!

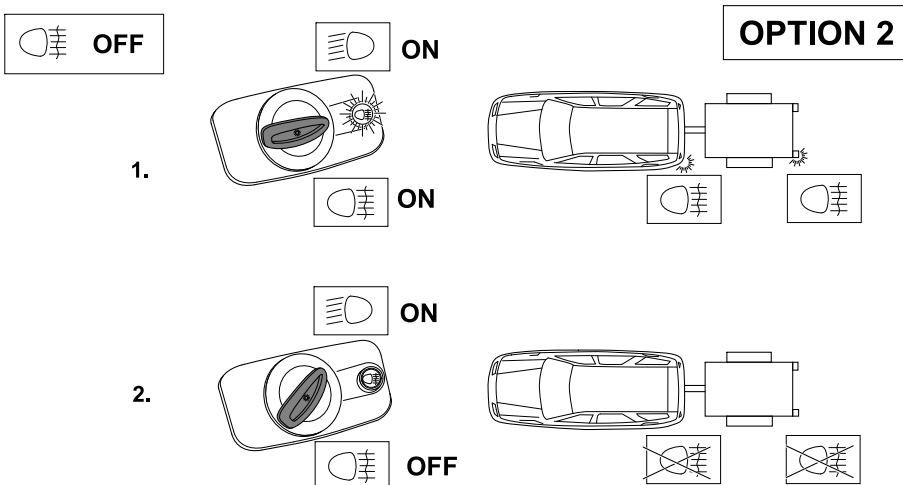
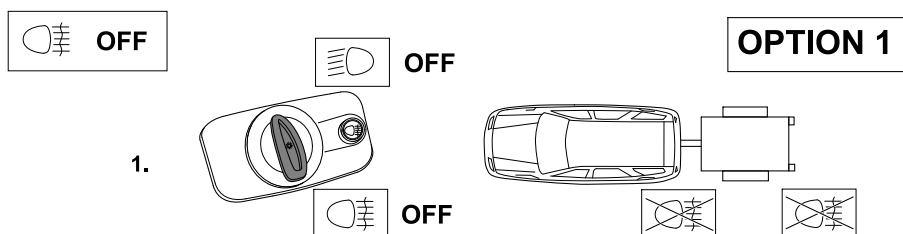
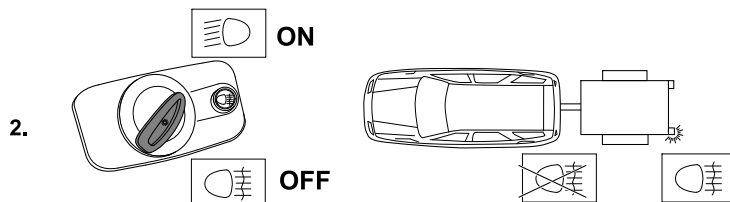
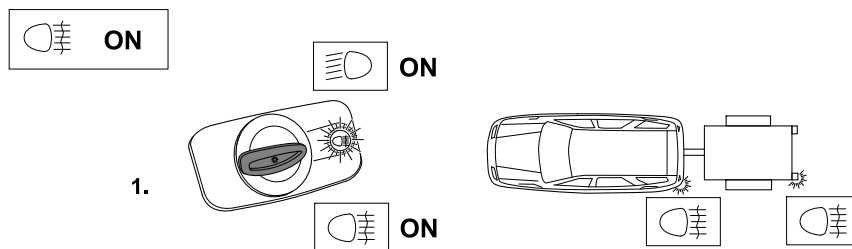

PROCEDURE OF SWITCHING OVER THE FOG LIGHT:

1. SWITCH ON POSITION LIGHTS
(OBLIGATORY CONDITION TO SWITCH ON REAR FOG LIGHT)
2. SWITCH ON REAR FOG LIGHT
(REAR FOG LIGHT IS SWITCHED ON, ON THE VEHICLE AND ON THE TRAILER)
3. SWITCH OFF REAR FOG LIGHT
(REAR FOG LIGHT IS SWITCHED ON ONLY ON THE TRAILER)

**PROCEDURE OF SWITCHING OFF THE REAR FOG LIGHT:
(WHEN POSITION LIGHTS ARE SWITCHED ON)**

OPTION 1

1. SWITCH OFF POSITION LIGHTS THEN AUTOMATICALLY REAR FOG LIGHT ON THE TRAILER WILL BE SWITCHED OFF

OPTION 2

1. KEEP POSITION LIGHTS ON AND SWITCH ON AGAIN REAR FOG LIGHT
(REAR FOG LIGHT IS ON, ON THE VEHICLE AND ON THE TRAILER)
2. SWITCH OFF REAR FOG LIGHT
(REAR FOG LIGHT WILL BE SWITCHED OFF, ON THE VEHICLE AND ON THE TRAILER)

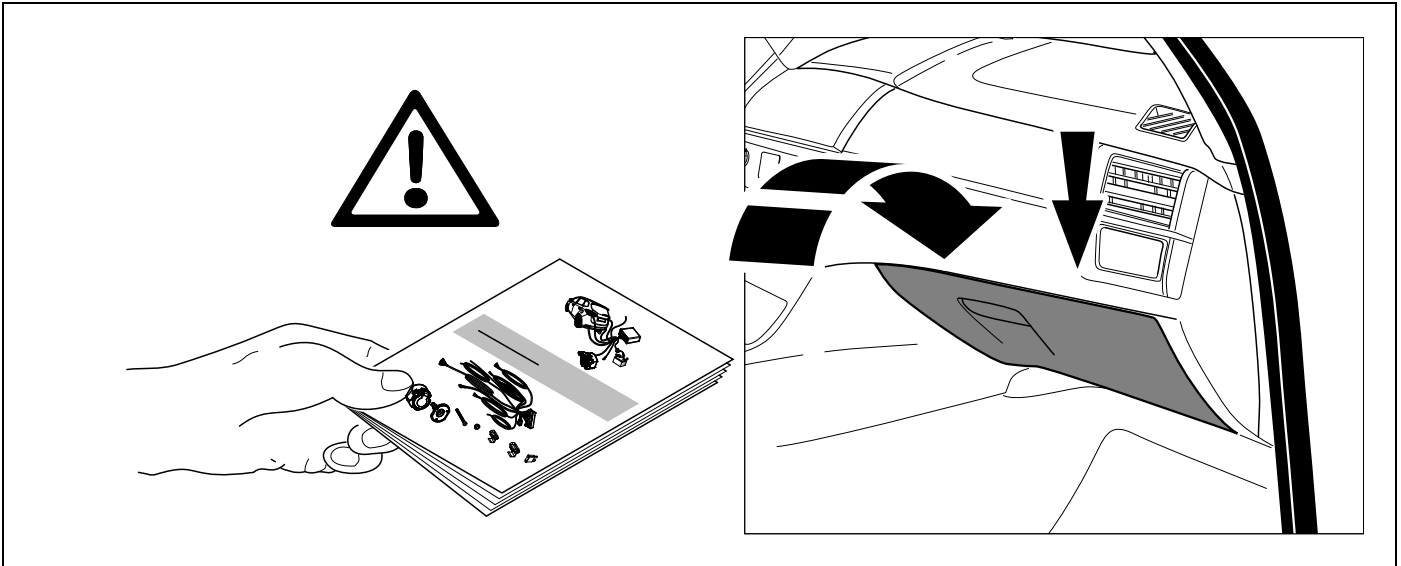

- D** Änderungen bezüglich Konstruktion, Ausstattung Farbe sowie Irrtum vorbehalten.
Angaben und Abbildungen unverbindlich
- GB** Subject to change in terms of construction, equipment and colour, and may contain errors.
The information and illustrations are non-binding.
- F** Sous réserve de modifications de la construction, de l'équipement, de la couleur et sous réserve d'erreurs. Les indications et les illustrations sont sans engagement.
- NL** Wijzigingen met betrekking tot constructie, uitvoering en kleur evenals vergissingen voorbehouden. Gegevens en afbeeldingen niet bindend.
- DK** Ændringer med hensyn til konstruktion, udstyr, farver samt fejl forbeholdes.
Oplysninger og illustrationer er forpligtende.
- N** Endringer angående konstruksjon, utstyr, farge og feiltagelse forbeholdes.
Opplysninger og illustrasjoner uforbindtlig.
- S** Med reservation för ändringar vad det gäller konstruktion, utrustning, färg samt för misstag. Uppgifterna och bilderna är inte bindande.
- FIN** Pidätämme oikeuden rakennetta, varustusta, väriä koskeviin sekä erehdyksestä johtuviin muutoksiin. Tiedot ja kuvat eivät ole sitovia.
- I** Con riserva di modifiche relative a progettazione, dotazione, colore ed errori.
Le indicazioni e figure sono fornite senza impegno.
- E** Reservadas las modificaciones respecto a diseño, equipamiento, color, así como error. Indicaciones y figuras sin compromiso.
- P** Reservamos o direito de alterações relativamente ao desenho, equipamento, cor, bem como de erro. Os dados e as gravuras não implicam compromisso da nossa parte.
- GR** Διατηρούμε κάθε επιφύλαξη ως προς αλλαγές σε σχέση με κατασκευή, εξοπλισμό, διαρρύθμιση, χρωματισμούς και λάθη παραδρομής.
- CZ** Změny, týkající se konstrukce, vybavení, barvy, jakož i omyly jsou vyhrazeny.
Údaje a vyobrazení jsou nezávazné.
- PL** Zastrzega się prawo do zmian dot. konstrukcji, wykończenia, kolorystyki oraz pomyłek.
Dane i ilustracje niewiążące.
- TR** Tasarım, donanım ve renk bakımından değişiklik yapma hakkı ve hata ve eksiklik mahfuzdur. Veriler ve resimler bağlayıcı değildir.
- H** A szerkezet, a kivétel és a szín változtatása, valamint a változások joga fenntartva.
Az adatok és az ábrák nem kötelező érvényűek.
- HR** Pravo promjena u svezi konstrukcije, opreme, boje kao i zabune oridžavamo.
Podaci i ilustracije su neobavezne.
- BUL** Запазени права по отношение на конструкцията, обзавеждането, цвета и грешки.
Данните и изображенията не са обвързващи.
- RO** Ne rezervăm dreptul unor modificări ale construcției, dotării, culorii și dreptul la erori
Datele indicate și imaginile sunt orientative.
- RU** Права на внесение изменений относительно конструкции, оснащения, окраски, а также на ошибки сохраняются. Данные и иллюстрации имеют примерный характер.
- LT** Pasiliekaama konstrukcijos, įrangos bei reikmenų, spalvos pakeitimų ir klaidų teisė.
Duomenys ir iliustracijos neįpareigojantys.
- LV** Tiek paturētas tiesības uz konstrukcijas, iekārtu, krāsu izmaiņām, kā arī kļūdīšanās.
Dati un attēli bez saistībām.
- EST** Konstruktsiooni, varustuse ja võervi osas muudatused ning eksimine lubatud.
Andmed ja joonised on mittesiduvad.
- SLO** Zadržana pravica do sprememb glede konstrukcije, opreme, barve ter pomote.
Podatki in slike so neobvezne.
- SK** Zmeny, ktoré sa týkajú konštrukcie, vybavenia, farby, ako aj omyly sú vyhradené.
Údaje a zobrazenia sú nezáväzné.

EXPERT SCHEMATIC WITHOUT TRAILER FLASHER CONTROL

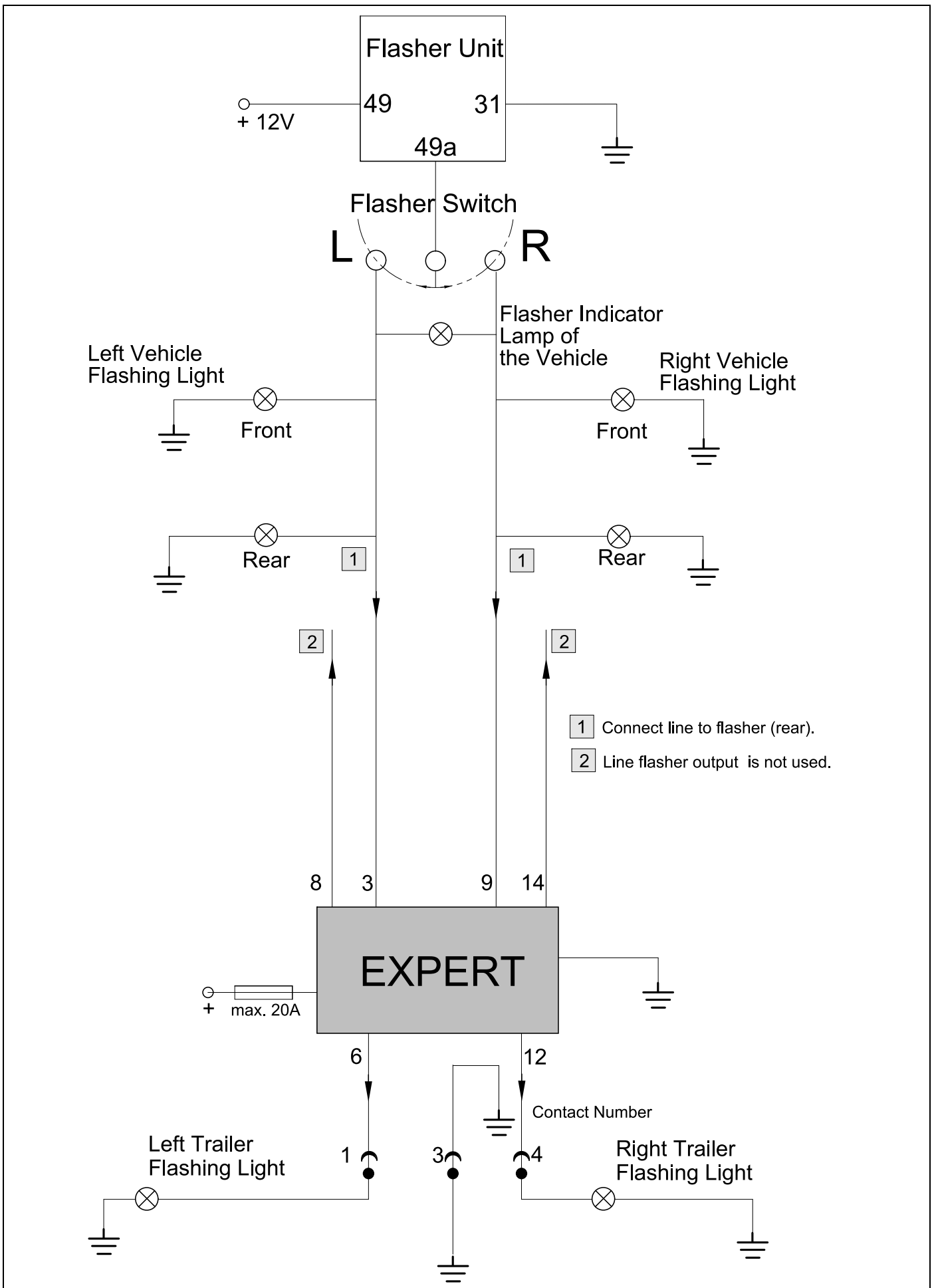

EXPERT SCHEMATIC WITH TRAILER FLASHER CONTROL

