

ECS FI-050-HX

Montageanleitung

E-Satz für Reisemobile bis 9 m Gesamtlänge

Artikelnr.: 1628321
21500658

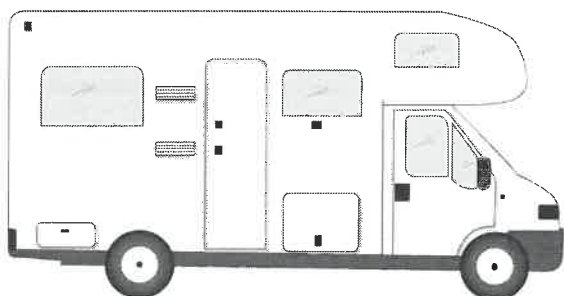

**E- Satz 13-polig für Euro- u. AL-KO-Chassis/Reisemobile ab Modell 06.2006 - Ducato/Jumper/Boxer
Inkl. LED-fähigem Modul mit Eigendiagnosefunktion und Lampensubstitution, 8-polig belegt.**

D	Einbauanleitung Elektro-Einbausatz für Anhängerkupplung / 13-polig / 12 Volt / ISO 11446
GB	Fitting instructions Electric wiring kit for towbars / 13-pin / 12 Volt / ISO 11446
F	Instructions de montage Faisceau pour attelage / 13 broches / 12 Volt / ISO 11446
I	Istruzione di montaggio Cablaggio elettrico per ganci di traino / 13 poli / 12 Volt / ISO 11446
E	Instrucciones de montaje Kits eléctricos para enganches de remolques / 13 pins / 12 Volt / ISO 11446
NL	Montagehandleiding Elektro-inbouwset voor aanhangerkoppeling / 13-polig / 12 Volt / ISO 11446

Servicehotline +49 (0) 5246 - 9210-19 erreichbar von 7:30 - 16:30 Uhr

20.07.2020

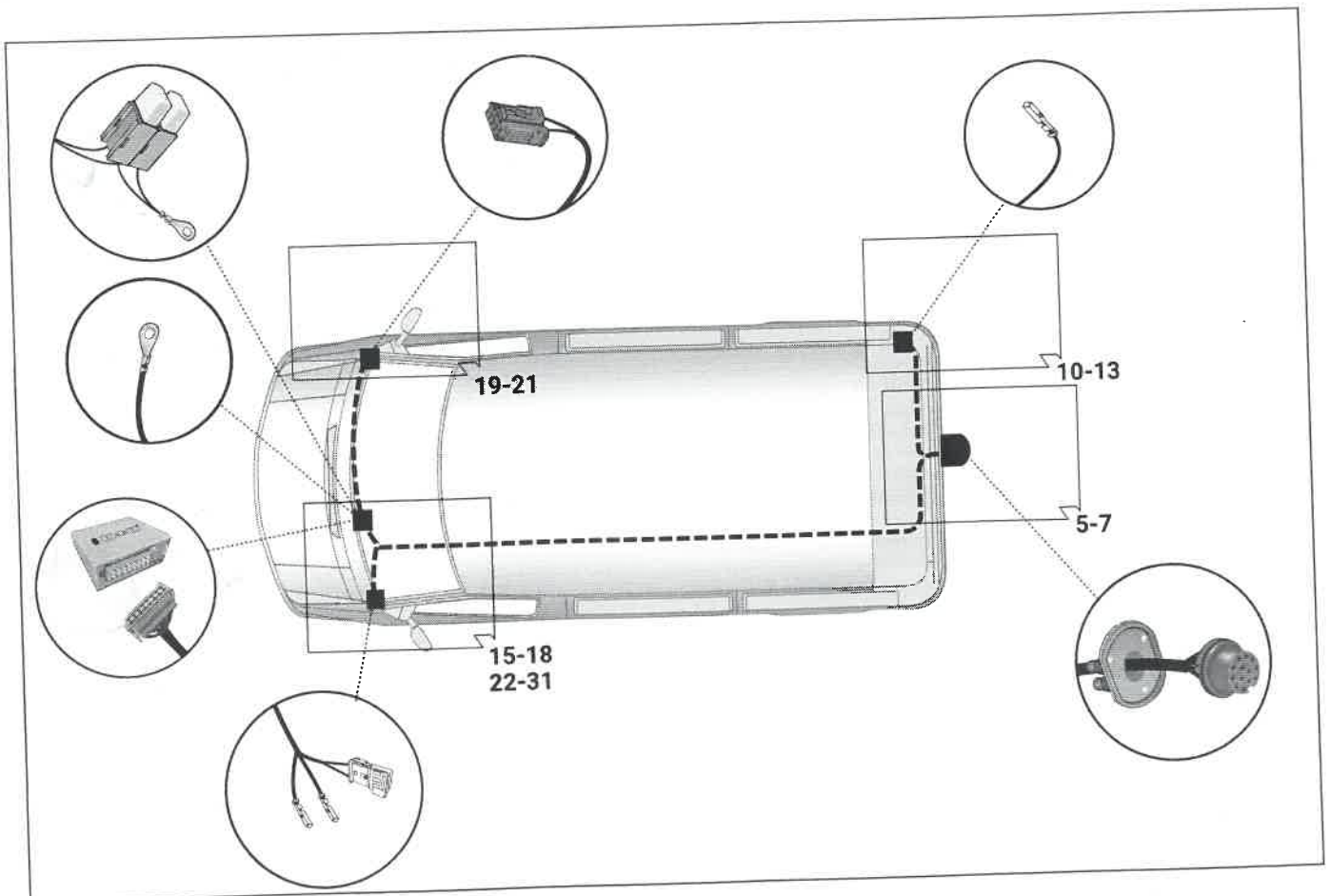
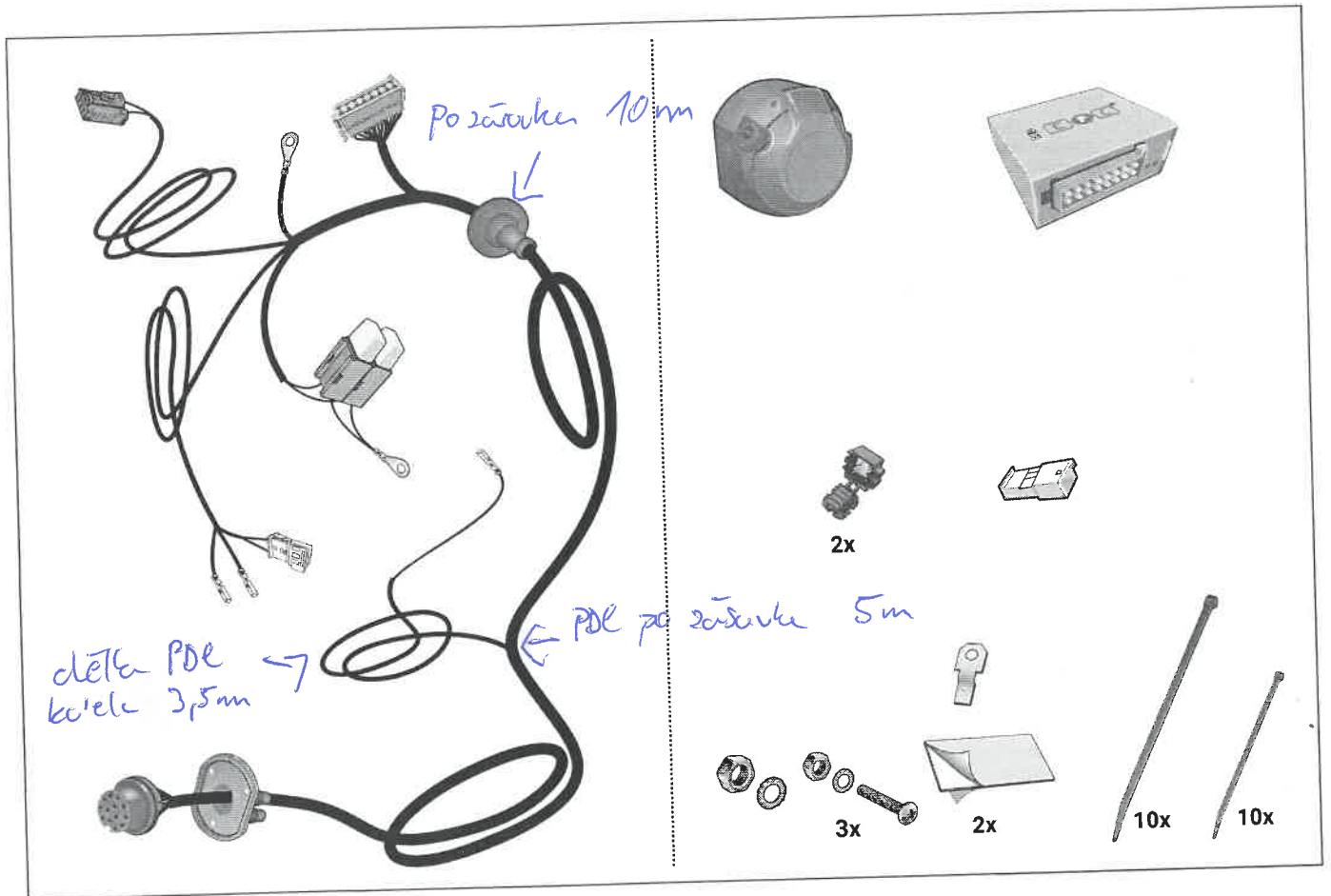

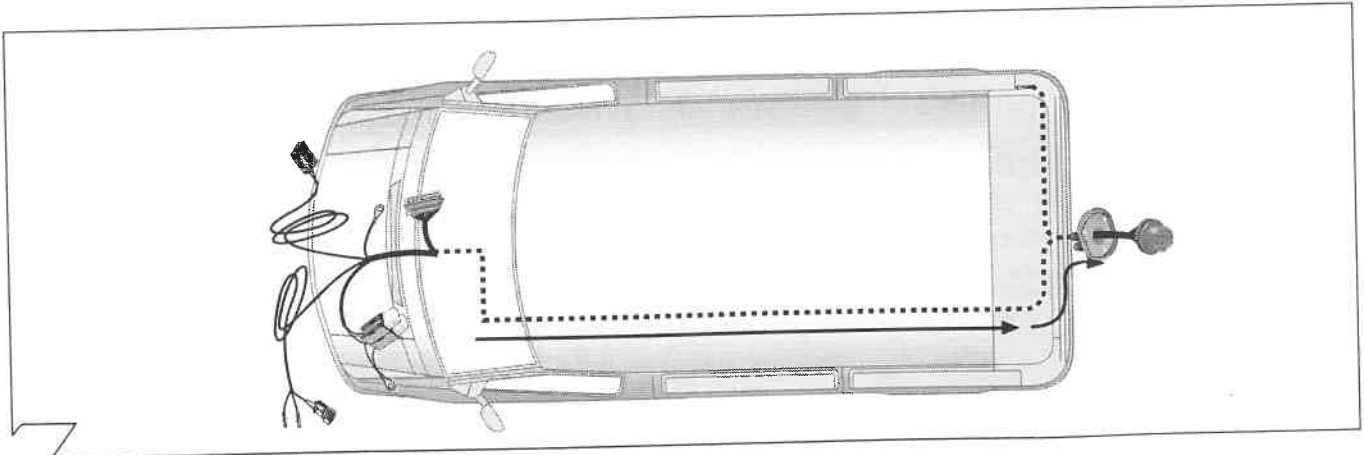

4

ISO 11446			
Belegung der Steckdose / Maximale Ausgangsleistung Socket configuration / Maximum power output Correspondance des contacts de la prise / Puissance de sortie maximale Abbinamento della presa / Uscita di alimentazione massima Indeling van de stekkerdoos / maximaal uitgangsvermogen			
	1/L	BK/WT	21W
	2	WT	21W
	1-8	3/31	XXXX
	4/R	BK/GN	21W
	5/58-R	GY/RD	52W
	6/54	BK/RD	63W
	7/58-L	GY/BK	52W
	8	BL/RD	42W
	9	XXXX	XXXX
	10	XXXX	XXXX
	10	11	XXXX
	12	XXXX	XXXX
	9	13	XXXX
OPTIONAL →			42

5

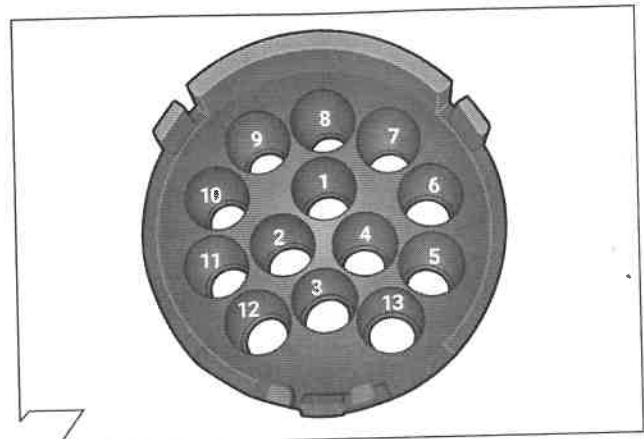

6

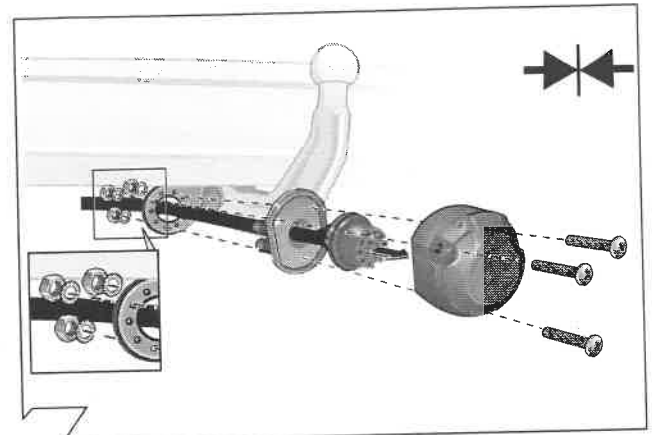

7

	GB	D	E	F	I	P	NL	DK	N	S	FIN	CZ	H	PL
BK	Black	Schwarz	Negro	Noir	Nero	Preto	Zwart	Sort	Svart	Svart	Musta	Černá	Fekete	Czarny
RD	Red	Rot	Rojo	Rouge	Rosso	Vermelho	Rood	Rød	Rød	Röd	Punainen	Červená	Piros	Czerwony
GN	Green	Grün	Verde	Vert	Verde	Verde	Groen	Grøn	Grønt	Grön	Vihreä	Zelená	Zöld	Zielony
OR	Orange	Orange	Naranja	Orange	Arancione	Laranja	Oranje	Orange	Orange	Orange	Oranssi	Oranzová	Narancs	Pomarańczowy
VT	Violet	Violett	Violeta	Violet	Viola	Violeta	Violet	Violet	Fiolett	Violett	Violetti	Fialová	Ibolya	Fioletowy
PK	Pink	Pink	Pink	Rose	Rosa	Cor-de-Rosa	Paars	Pink	Pink	Rosa	Pinkki	Růžová	Rózsaszín	Różowy
BL	Blue	Blau	Azul	Bleu	Blu	Azul	Blauw	Blå	Blått	Blá	Sininen	Modrá	Kék	Niebieski
YL	Yellow	Gelb	Amarillo	Jaune	Giallo	Amarelo	Geel	Gul	Gult	Gul	Keltainen	Zlutá	Sárga	Żółty
WT	White	Weiss	Blanco	Blanc	Bianco	Branco	Wit	Hvid	Hvitt	Vt	Valkoinen	Bílá	Fehér	Biały
BR	Brown	Braun	Marrón	Brun	Marrone	Marrom	Bruin	Brun	Brunt	Brun	Ruskea	Hnědá	Barna	Brazowy
GY	Grey	Grau	Gris	Gris	Grigio	Cinzeno	Grijs	Grå	Grått	Grå	Harmaa	Sedá	Szürke	Szary

8

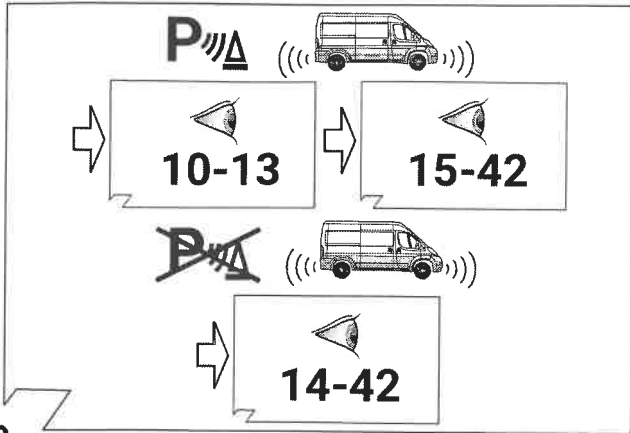

9

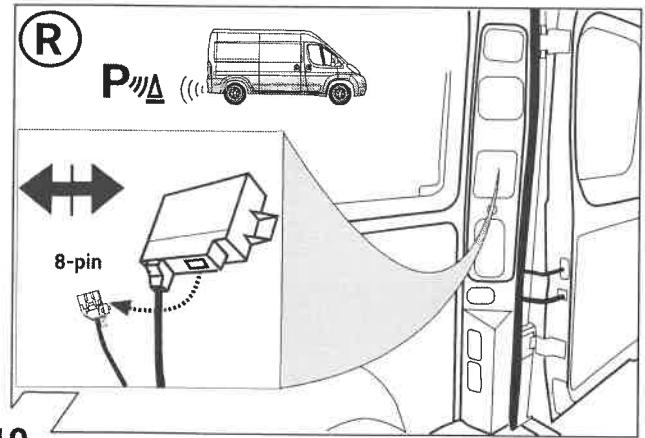

10

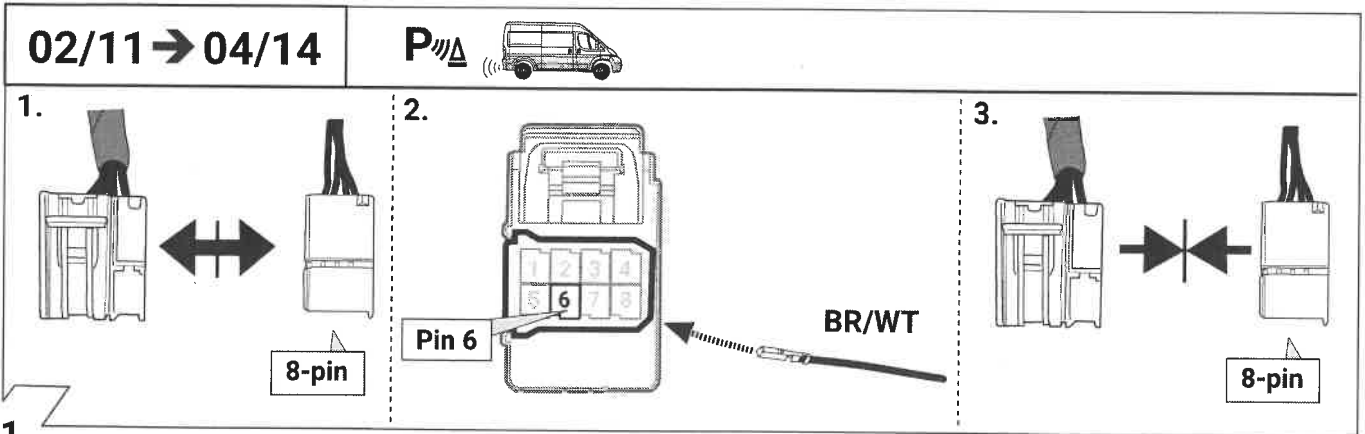

11

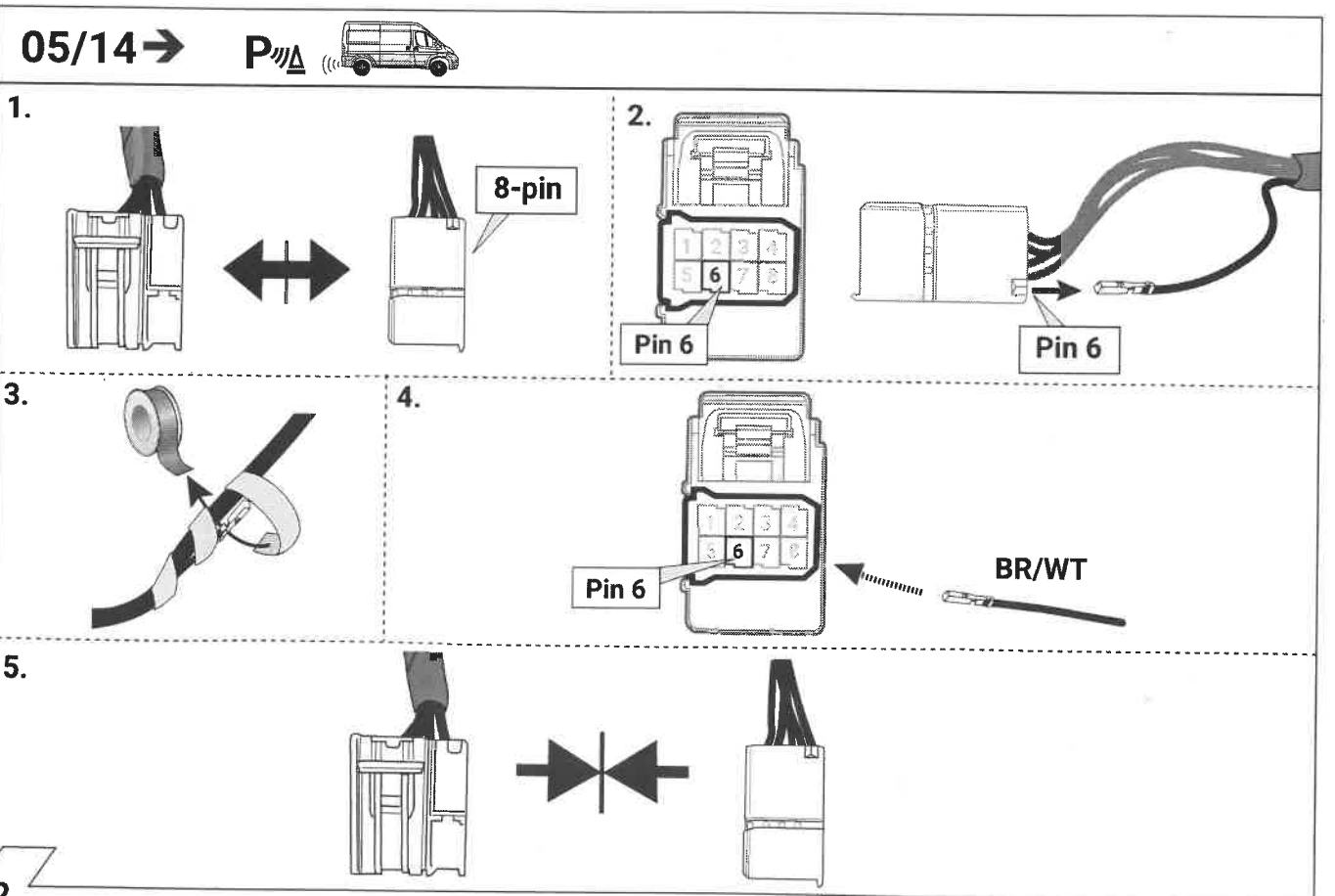

12

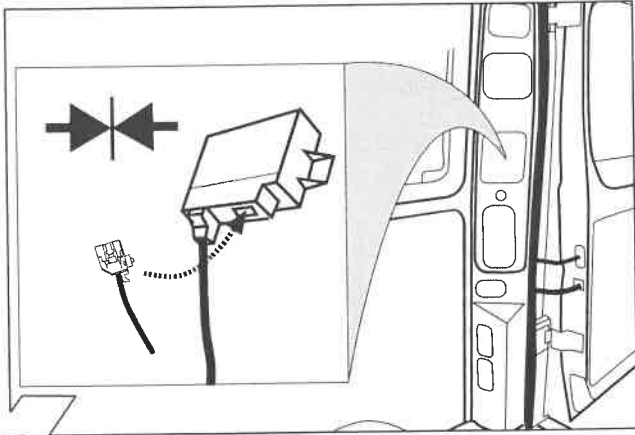

13

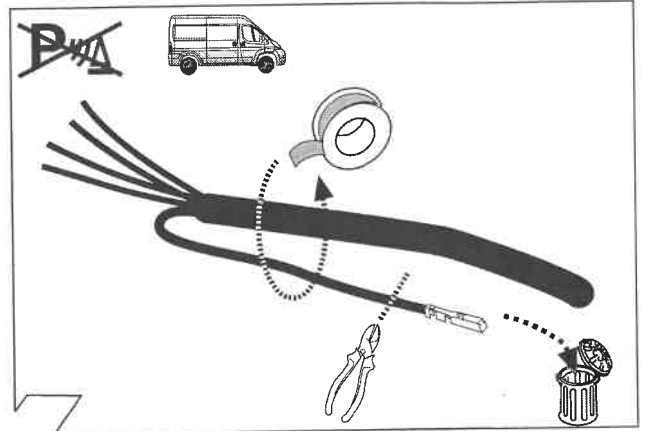

14

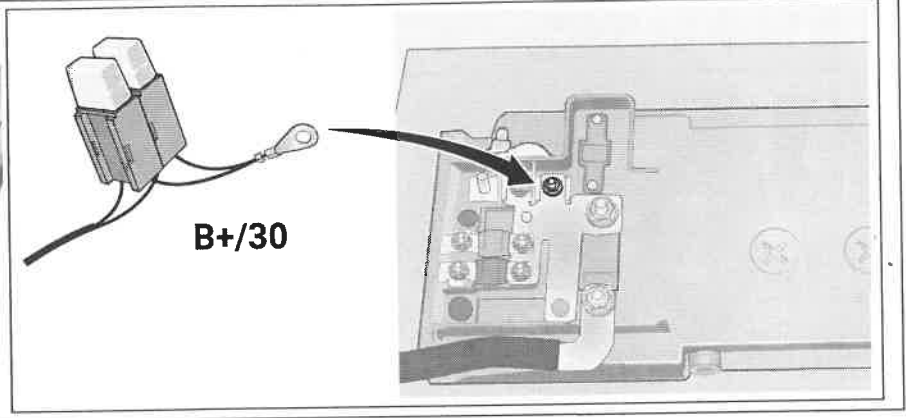
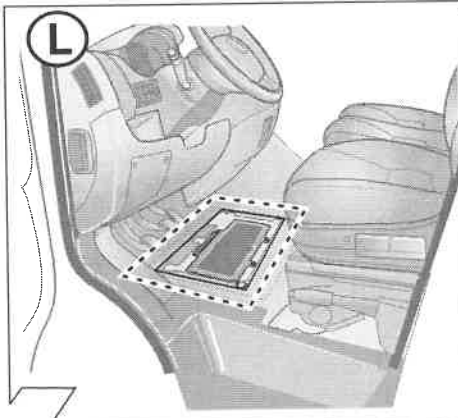

15

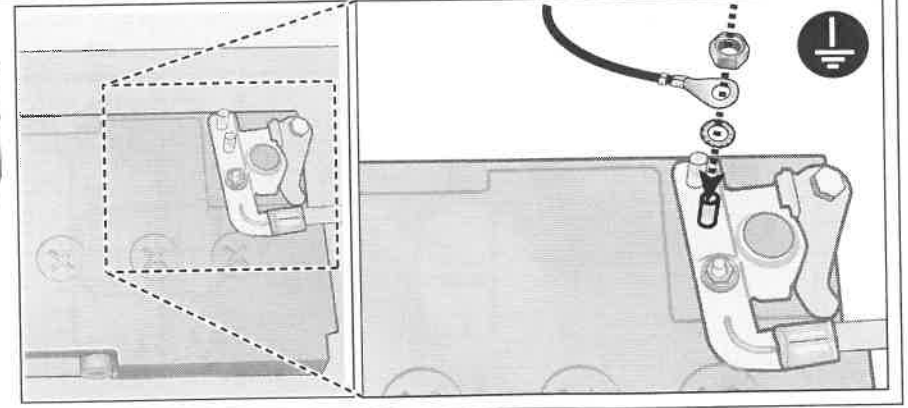
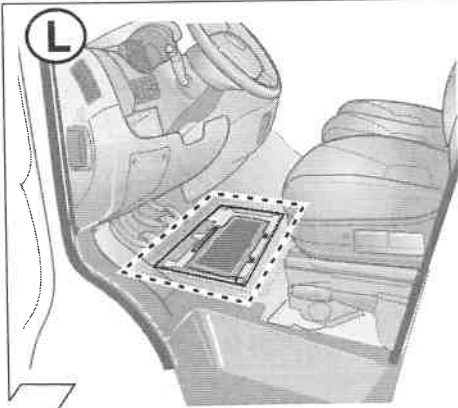

16

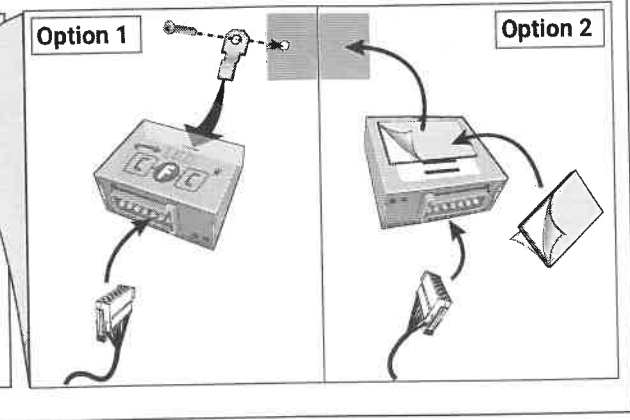
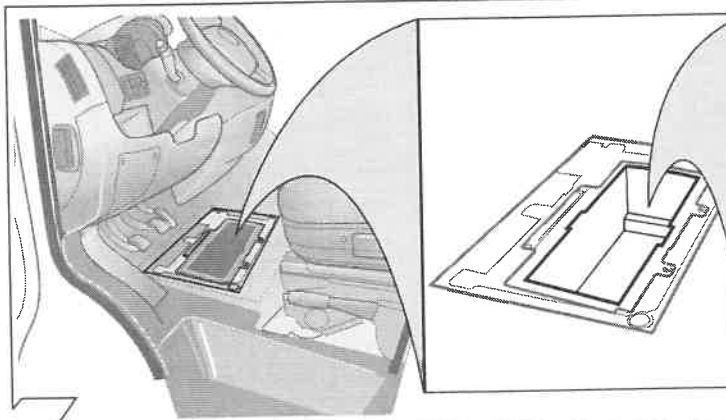

17

06/06 → 01/11

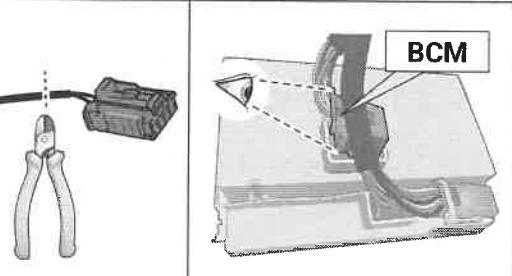
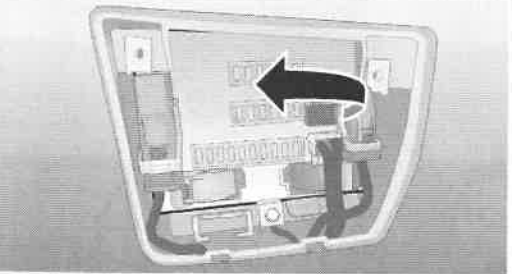
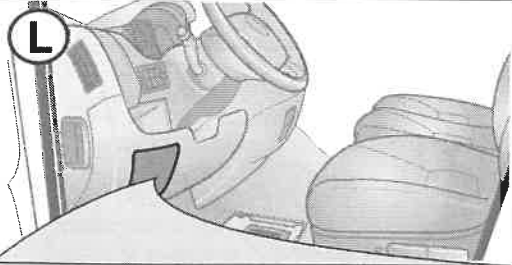

CAN-Data Wire

∞ BK/PK WT/PK ⚠

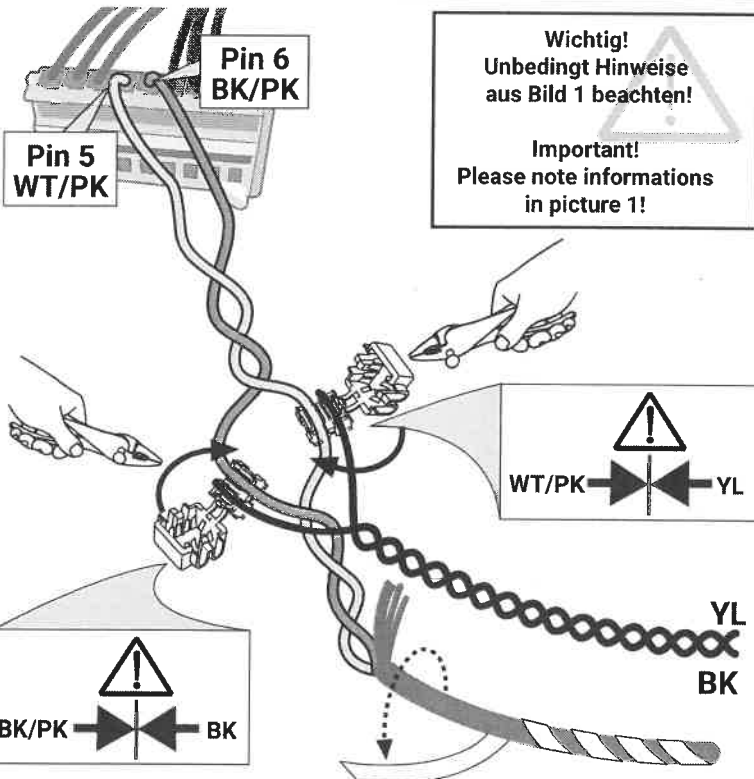

18

02/11 →

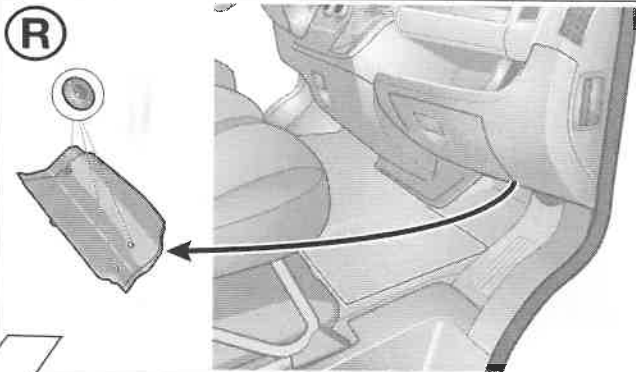

Option 1

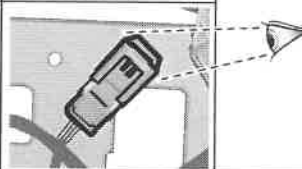

→ 20

Option 2

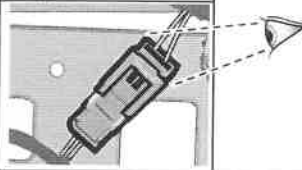

→ 21

19

02/11 →

Option 1

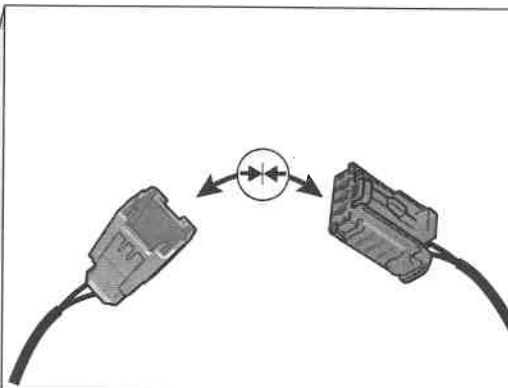
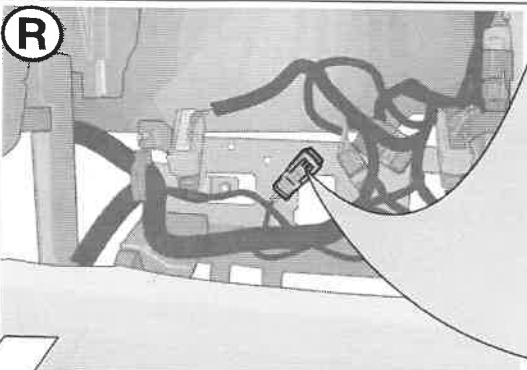

Wichtig!
Unbedingt Hinweise aus Bild 1 beachten!
Important!
Please note informations in picture 1!

20

02/11 → Option 2

(R)

CAN-Data Wire

Pin 3

Pin 2

Pin 2

Pin 3

Wichtig!
Unbedingt Hinweise aus Bild 1 beachten!

Important!
Please note informations in picture 1!

Pin 3 → YL

Pin 2 → BK

YL

BK

21

06/06 → 01/11

(L)

BCM

22

06/06 → 01/11

BCM

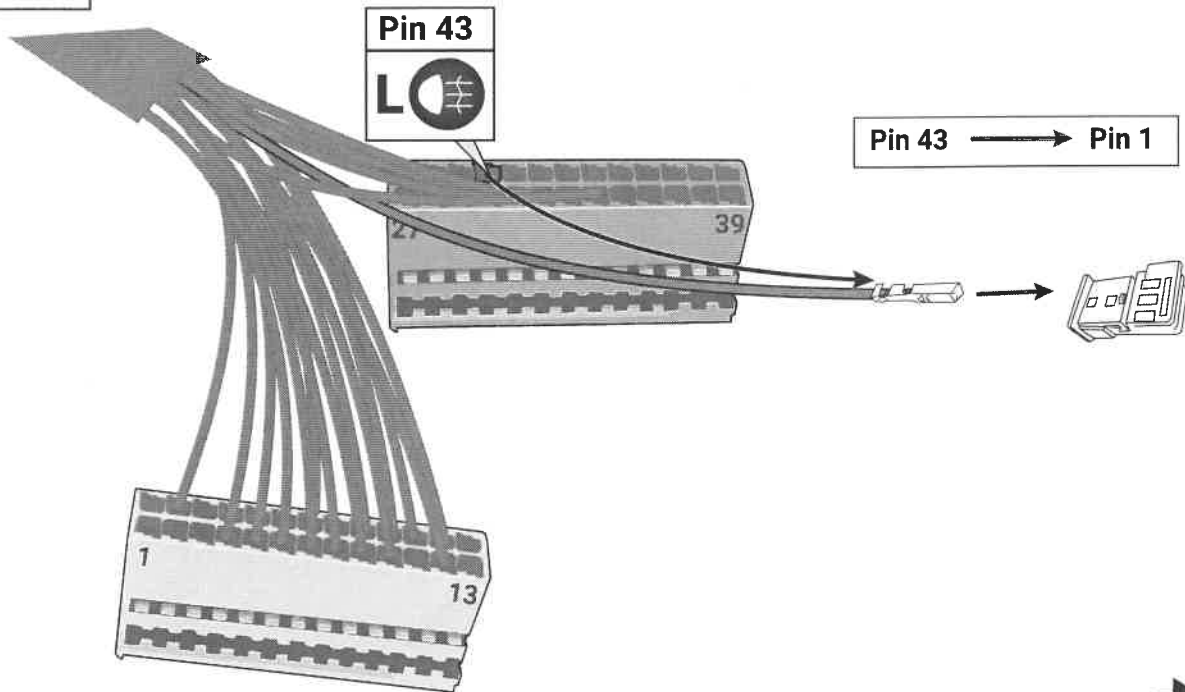

23

06/06 → 01/11

BCM

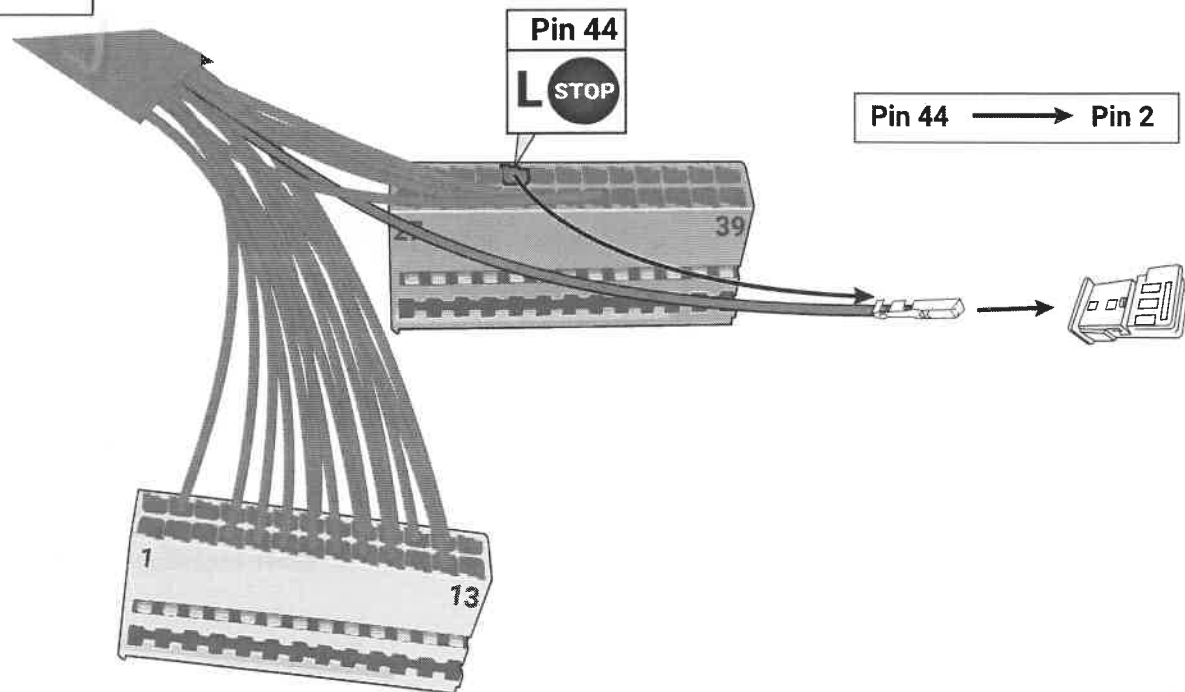

24

06/06 → 01/11

BCM

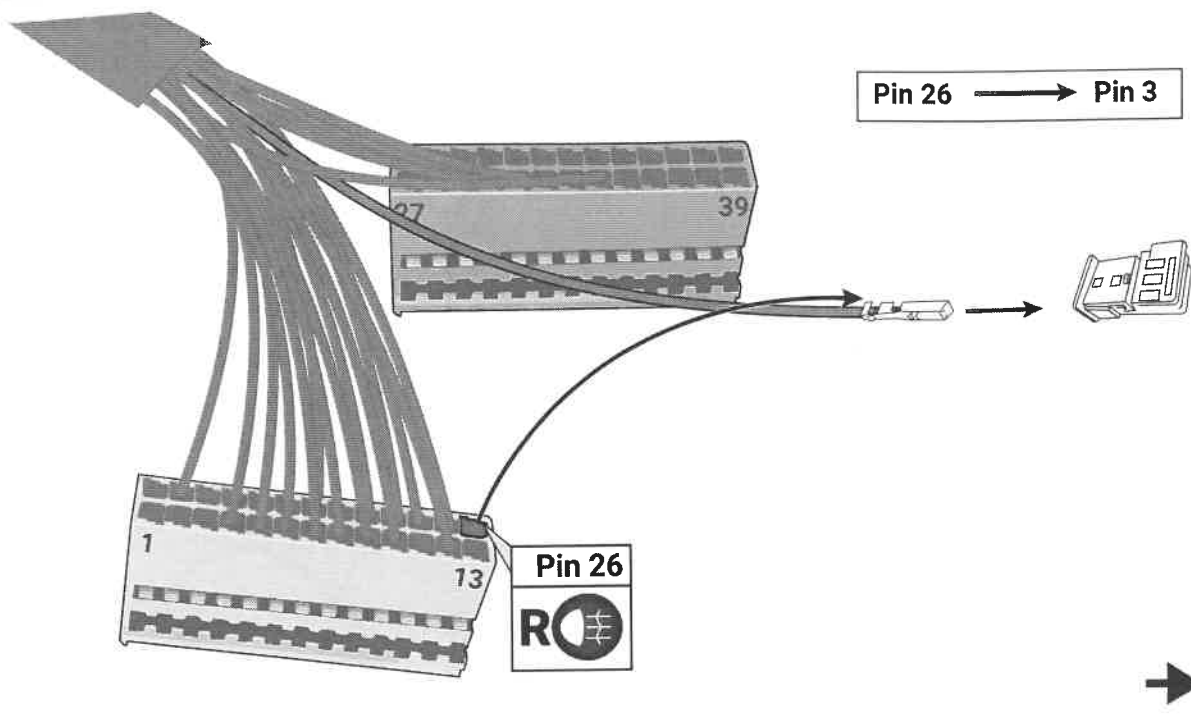

25

06/06 → 01/11

BCM

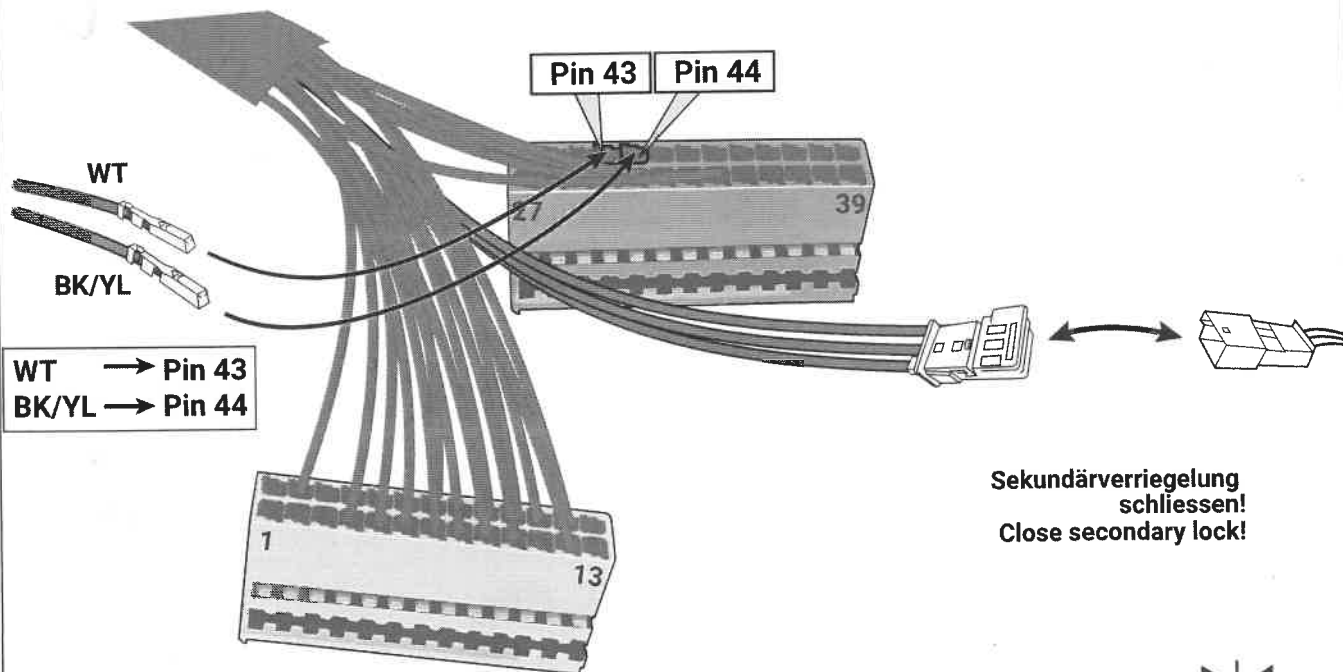

26

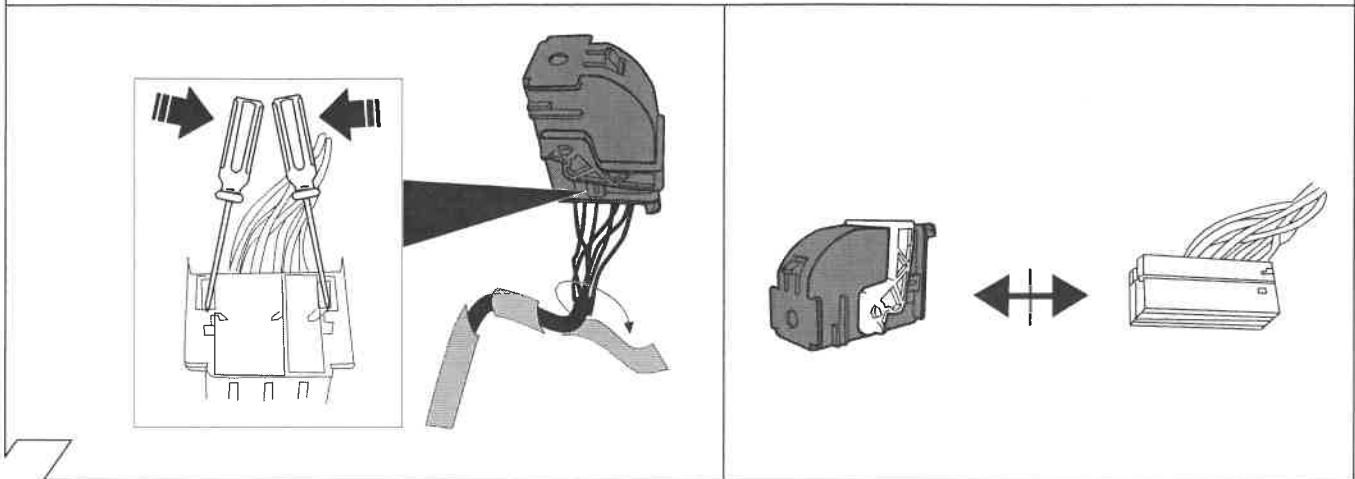
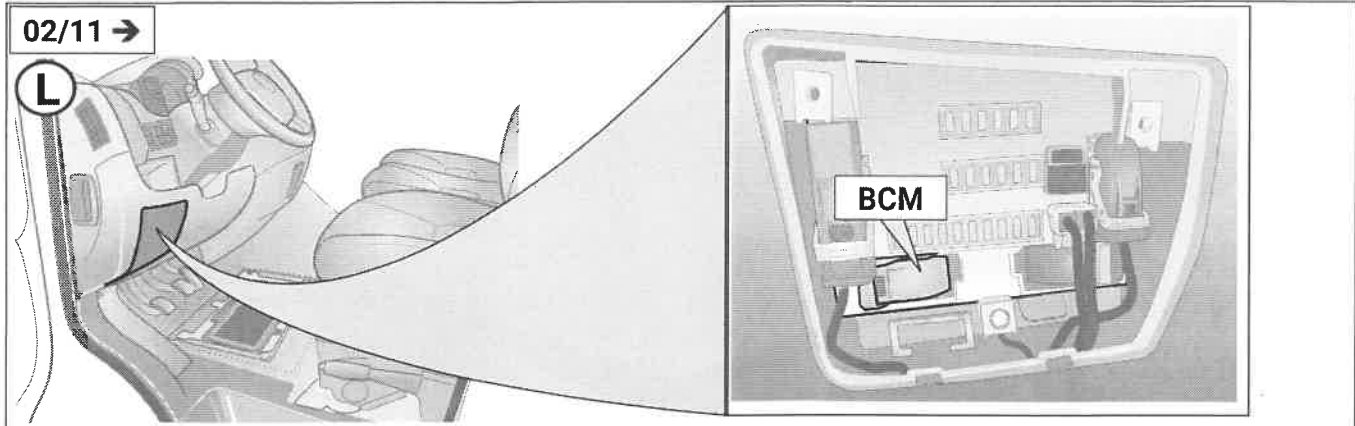

27

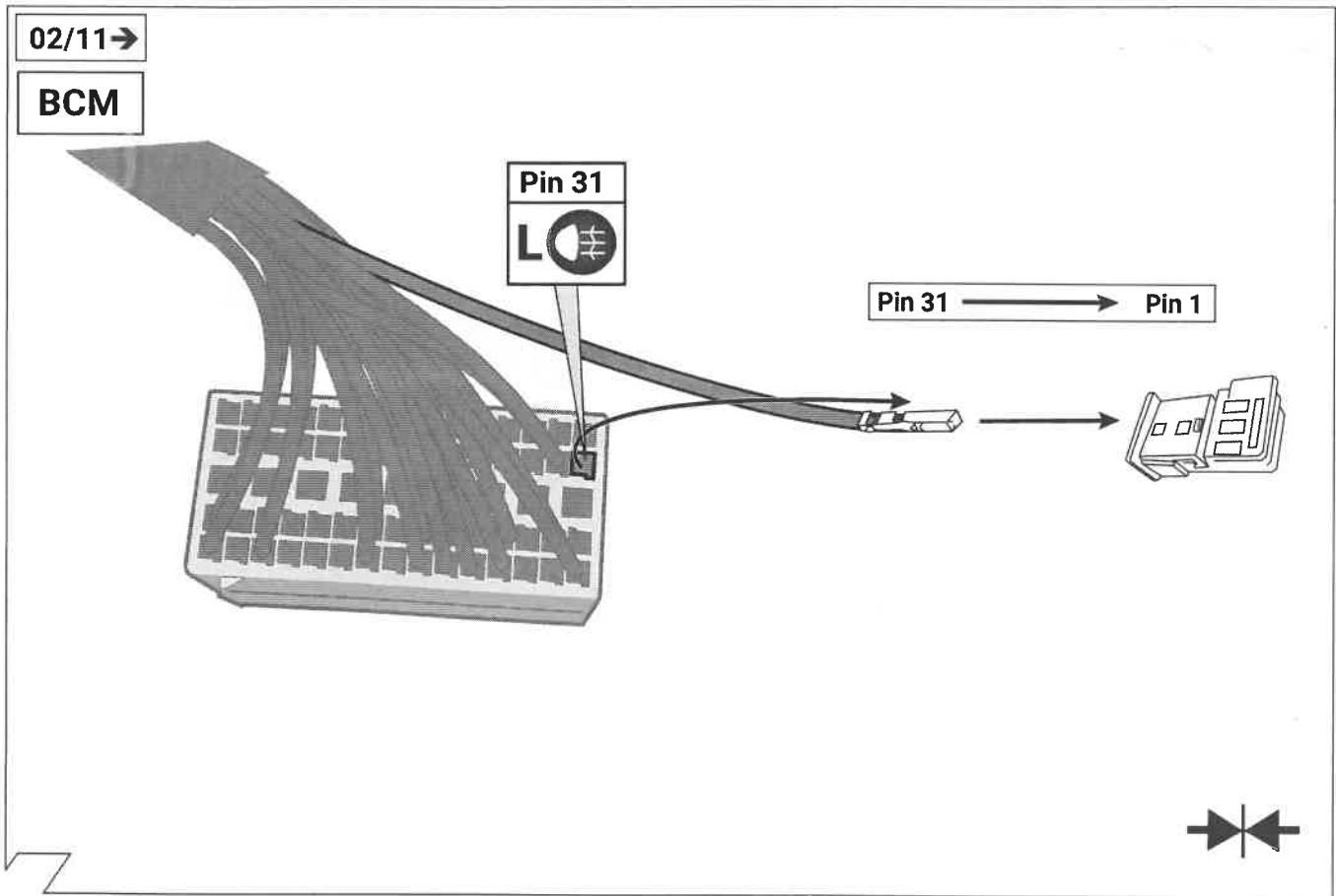

28

02/11→

BCM

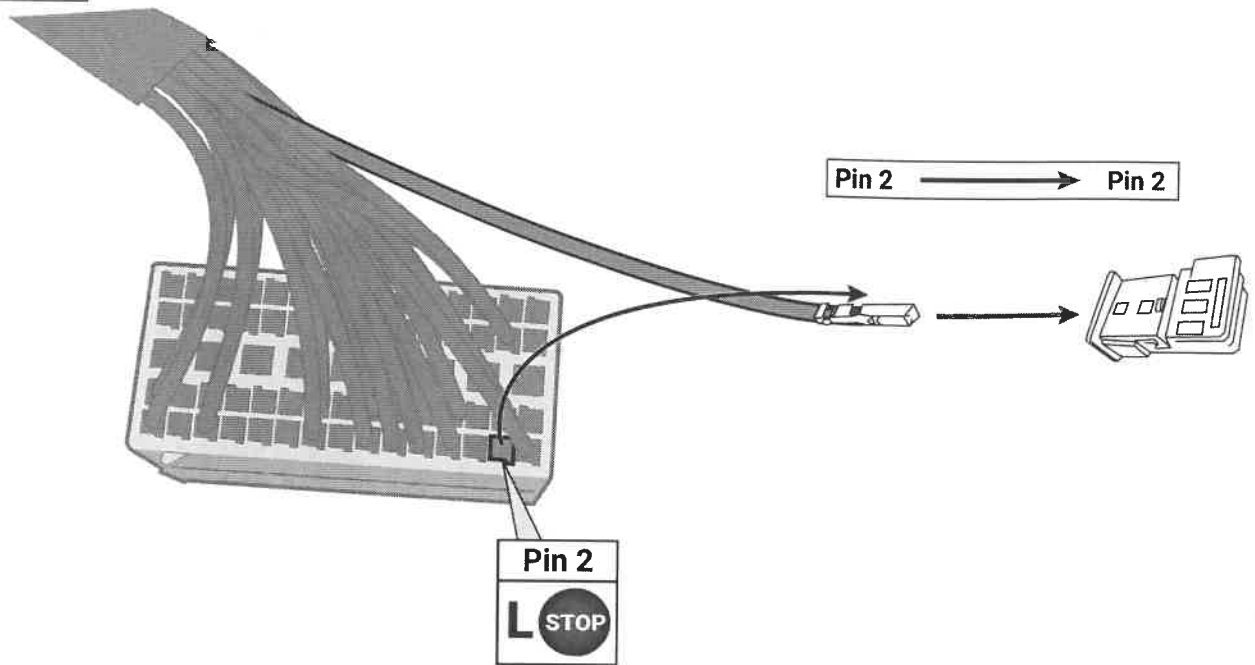

29

02/11→

BCM

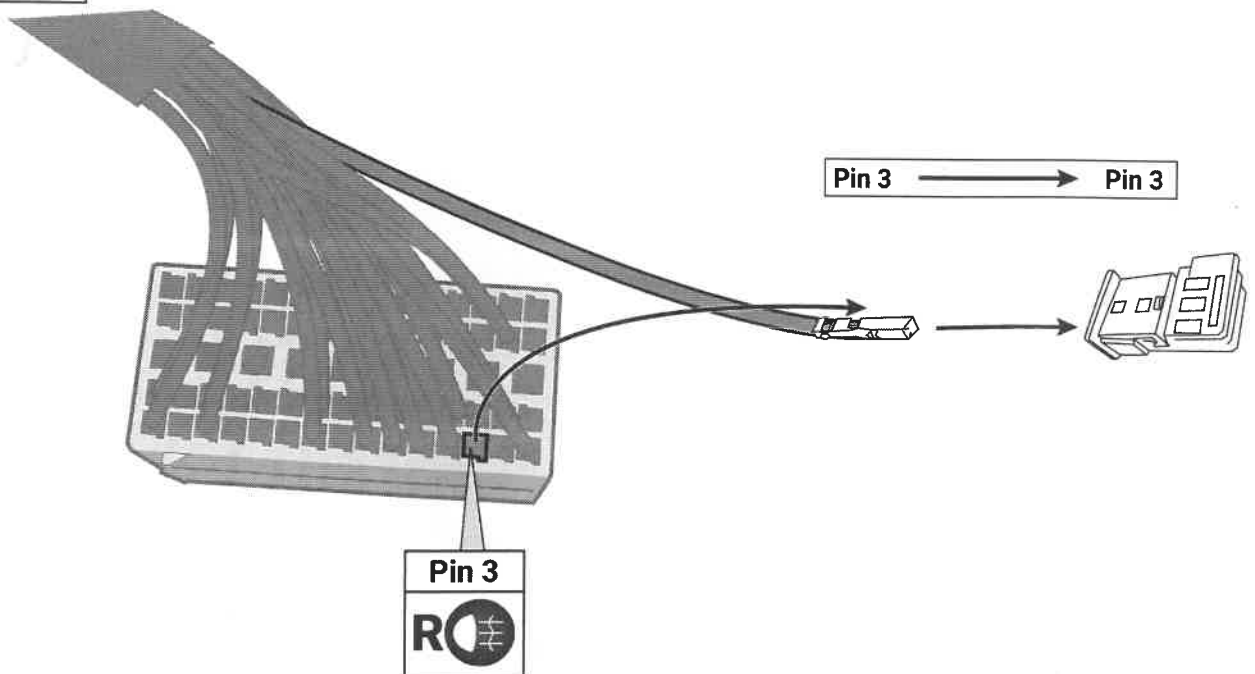

30

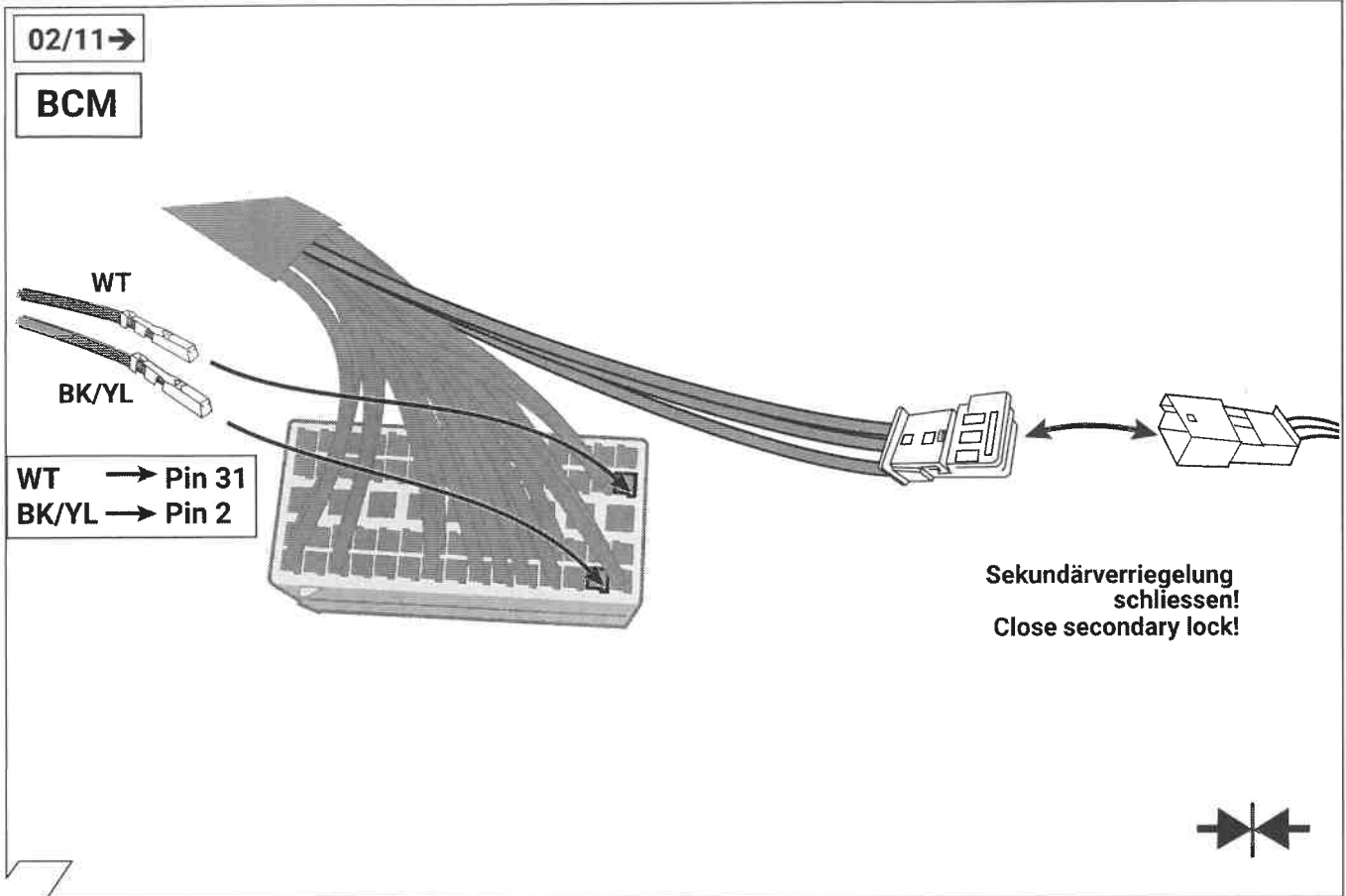

31

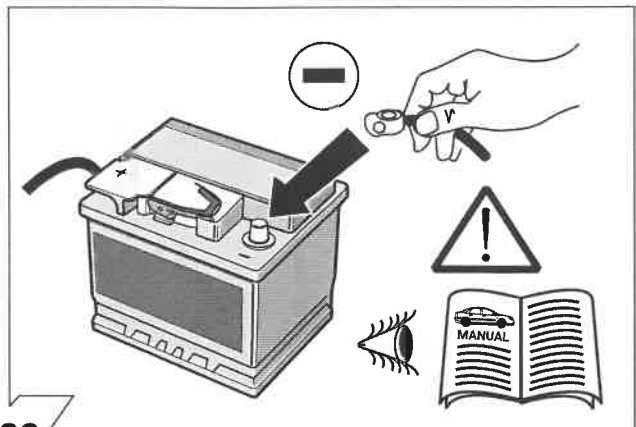

32

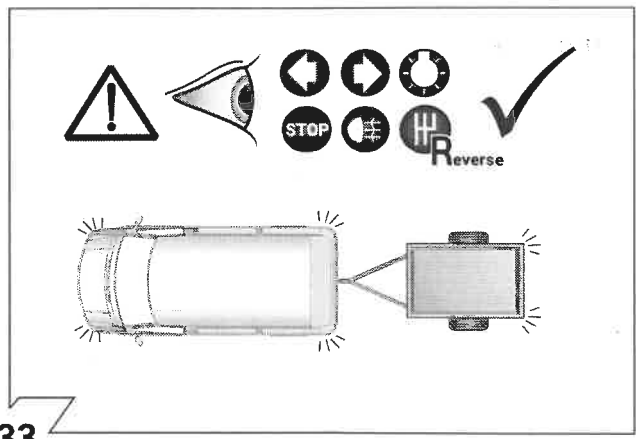

33

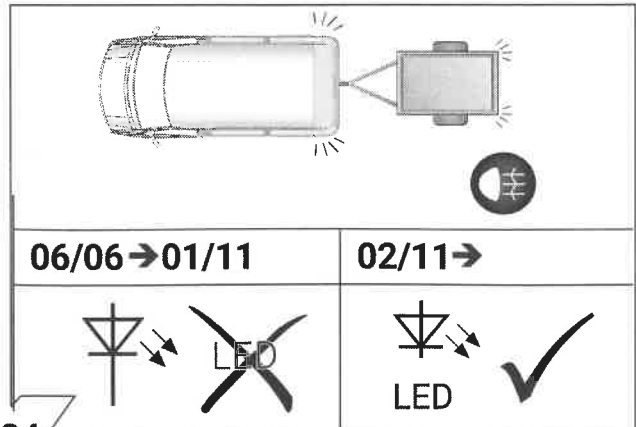

34

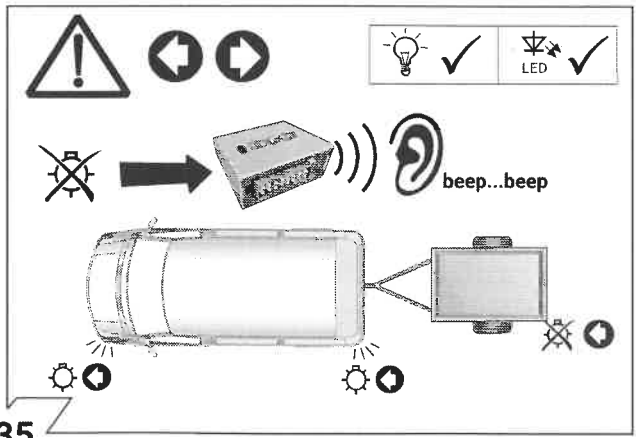

35

36

! STOP

SETUP

1.

2. Ignition ON

3.

4.

OPTIONAL

Trailer Simulator for 7- and 13-pin Sockets

Part-no. 50400522

37

Optional: Adapter socket 62930000

38

39





40



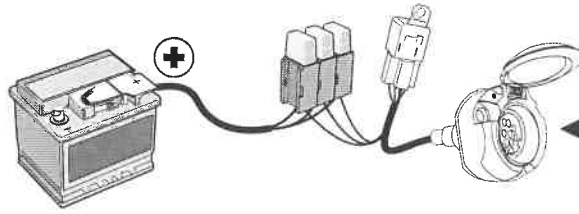





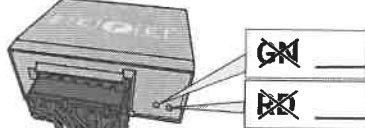

41

OPTIONAL

**Erweiterungssatz
Extension Kit
No. 22500627
3504E4X250**

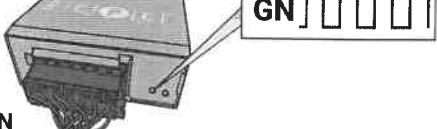

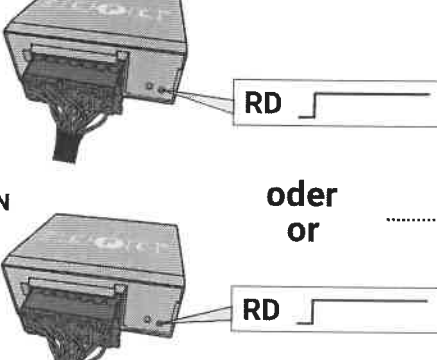
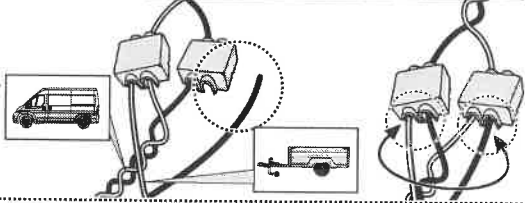
	9
	10
	10
	12
	9
	13

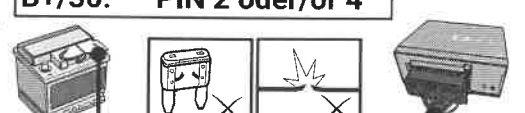
D Diagnosefunktion der Kontroll-LED's	GB Diagnosis function of control LEDs	F Fonction diagnostic des LED de contrôle
I Funzione di diagnostica dei LED di controllo	E Función de diagnóstico de los LEDs de control	NL Diagnosefunctie van de controle-LED's
 Ignition OFF	 No CAN-Data =	 Standby / Sleepmode ✓
 Ignition ON	 GN	 ✓
 Ignition ON	 GN	 ✓
 Ignition ON	 RD	<div style="border: 1px solid black; padding: 5px; text-align: center;"> CAN-Data Wire PIN 13+14 </div>  <div style="border: 1px solid black; padding: 5px; text-align: center;"> /31: PIN 1 </div>  <div style="border: 1px solid black; padding: 5px; text-align: center;"> B+/30: PIN 2 oder/or 4 </div> 
<p>D Blinküberwachung und Leuchten-Substitution bei Ausfall der Anhänger-Blinkleuchten</p> <p>Der Ausfall von einer oder von beiden Anhänger-Blinkleuchten wird je nach Fahrzeugtyp und Ausführung des verbauten Elektro-Einbausatzes wie folgt angezeigt:</p> <ul style="list-style-type: none"> • Erhöhung / Verdoppelung der Blinkfrequenz • Volltextmeldung im Display / Kombi-Instrument • Aktivierung Kontrollleuchte für Lampenausfall • Akustische Warnung via Buzzer oder Voice-Message <p>Bei einem Blinkleuchten-Ausfall ersetzt die gleichseitige Rückleuchte durch Aufleuchten in der Blinkfrequenz eine defekte Anhänger-Blinkleuchte (↗ Leuchten-Substitution!).</p>	<p>GB Indicator failure detection and lamp substitution if the trailer indicators fail</p> <p>The failure of a single or on both trailer indicators will be shown depending on the type of vehicle and electric kit installed as follows:</p> <ul style="list-style-type: none"> • Increase in the flashing frequency • Text message in the Display / combi-instrument • Activated control lamp for light failure • Audible warning via Buzzer or Voice-Message <p>If an indicator fails the left or right rear light compensates the faulty indicator by flashing at the correct frequency! (↗ lamp substitution).</p>	
<p>F Surveillance des clignotants et substitution des feux en cas de panne des clignotants de la remorque</p> <p>La panne d'un ou des deux clignotants de la remorque est indiquée de la façon suivante en fonction du type de véhicule et du modèle de module électrique monté:</p> <ul style="list-style-type: none"> • Augmentation / doublement de la fréquence de clignotement • Message complet sur l'affichage / l'instrument combiné • Activation du voyant de contrôle pour panne de lampe • Avertissement sonore via buzzer ou message vocal <p>En cas de panne du clignotant, le feu arrière du côté de la panne remplace un clignotant de remorque défectueux en s'allumant à la même fréquence que le clignotant! (↗ Substitution des feux!).</p>	<p>I Controllo delle frecce e sostituzione delle lampade in caso di guasto alle frecce del rimorchio</p> <p>A seconda del tipo di veicolo e della versione del kit elettrico montato, il guasto di una o di entrambe le frecce del rimorchio si manifesta come segue:</p> <ul style="list-style-type: none"> • Aumento/raddoppio della frequenza di lampeggiamento • Full text display / strumento combinato • Attivazione della spia di controllo per il guasto lampada • Segnalazione acustica mediante cicalino o messaggio vocale <p>In caso di guasto alla luce della freccia, la luce posteriore dello stesso lato si accende sostituendo nella frequenza del lampeggio la freccia difettosa del rimorchio. (↗ Sostituzione delle lampade!).</p>	
<p>E Control de intermitentes y sustitución de lámparas en caso de fallo de los intermitentes del remolque</p> <p>El fallo de uno o de ambos intermitentes del remolque se indicará de la siguiente manera en función del tipo del vehículo y de la ejecución del juego de montaje eléctrico montado:</p> <ul style="list-style-type: none"> • Aumento/duplicación de la frecuencia de parpadeo • Mensaje de texto completo en el display/instrumento combinado • Activación de la lámpara piloto para el fallo de lámparas • Advertencia acústica mediante zumbador o mensaje de voz <p>Si hay un fallo de intermitente, la luz trasera del mismo lado reemplazará la lámpara defectuosa del intermitente parpadeando en la misma frecuencia que el intermitente (↗ Sustitución de lámparas!).</p>	<p>NL Knippercontrole en lampvervanging bij uitval van de knipperlampen van een aanhangwagen</p> <p>De uitval van één of beide knipperlampen van een aanhangwagen wordt afhankelijk van het voertuigtype en de uitvoering van de ingebouwde elektroset als volgt aangegeven:</p> <ul style="list-style-type: none"> • Verhoging / verdubbeling van de knipperfrequentie • Volledige tekstweergave op het display / combi-instrument • Activering controlelampje voor uitval van een lamp • Akoestische waarschuwing via buzzer of Voice-Message <p>Bij een uitval van (een) knipperlamp(en) vervangt het gelijkzijdige achterlicht door aan te flitsen bij de knipperfrequentie een defecte knipperlamp van een aanhangwagen (↗ Lampvervanging!).</p>	

ERKLÄRUNG SYMBOLE	SYMBOL EXPLANATION	EXPLICATION DES SYMBOLES	SPIEGAZIONE DEI SIMBOLI	EXPLICACIÓN DE LOS SIMBOLES	VERKLARING SYMBOLEN
(D)	(GB)	(F)	(I)	(E)	(NL)
linke (58-L) bzw. rechte (58-R) Schlussleuchte	left (58-L) respectively right (58-R) tail light	feu arrière gauche (58-L) respectivement droite (58-R)	luce posteriore sinistra (58-L) rispettivamente destra (58-R)	pliato trasero izquierdo (58-L) respectivamente derecho (58-R)	Linker (58-L) c.q. rechter (58-R) achterlicht
Bremsleuchte (54) / 3. Bremsleuchte (54)	stop light (54) / high mounted, third stop light (54)	feu de stop (54) / 3ième feu de stop (54)	luce d'arresto (54) / 3. luce d'arresto (54)	luz de freno (54) / tercera luz de freno (54)	Remlicht (54) / 3e remlicht (54)
Fahrtrichtungsanzeiger links	turn signal indicator left	feu indicateur de direction gauche	indicatore di direzione sinistra	luz indicadora de dirección de marcha izquierda	Richtingaanwijzer links
Fahrtrichtungsanzeiger rechts	turn signal indicator right	feu indicateur de direction droite	indicatore di direzione destra	luz indicadora de dirección de marcha derecha	Richtingaanwijzer rechts
Nebelschlussleuchte(n)	rear fog light(s)	feu (x) arrière (s) de brouillard	fendinebbia	luz (-ces) trasera (s) antinebla (s)	Mistachterlicht(en)
Rückfahrleuchte(n)	reversing light(s)	feu (x) de marche arrière	luce (i) retromarcia	luz (-ces) de marcha atrás	Achteruitrijlicht(en)
Dauerstrom / Steckdose 13P Kammer 9	Permanent power supply / 13pin socket, chamber 9	courant continue / prise de courant à 13 pôles, compartiment 9	alimentazione continua / presa 13 poli, camera 9	positivo continuo / caja de enchufe a 13 polos, cámara 9	Continuustroom / stekker doos 13P kamer 9
Ladeleitung / Steckdose 13P Kammer 10	charging wire for trailer battery / 13pin socket, chamber 10	cable de charge / prise de courant à 13 pôles, compartiment 10	cavo di carica / presa 13 poli, camera 10	cable de carga / caja de enchufe a 13 polos, cámara 10	Laadraad / stekkerdoos 13P kamer 10
Anhänger / Anhängererkennung	trailer / trailer recognition	remorque / détection de la fonction "remorque"	rimorchio / riconoscimento rimorchio	remolque / detección del remolque	Aanhanger / aanhangeridentificatie
Dauerstrom / permanente Stromversorgung	Permanent current power supply	courant continue / alimentation électrique permanente	corrente / alimentazione continua	positivo continuo / alimentación de corriente permanente	Continuustroom / permanente stroomvoorziening
Masse (31)	Ground or Earth (31)	masse (31)	masse (31)	masa (31)	Massa (31)
Batteriepolklemme Anschluss Minus	ground connection battery terminal lug	borne "moins" de la batterie	connessione negativa della batteria	conexión negativa de batería	Accupoolklem aansluiting min
Batteriepolklemme Anschluss Plus	positive connection battery terminal lug	borne "plus" de la batterie	connessione positiva della batteria	conexión positiva de batería	Accupoolklem aansluiting plus
Sicherung / Sicherungsstärke 20 Ampère	fuse / fuse capacity 20 Ampère	fusible / ampères	fusibile / fusibile con capacity 20 Ampère	fusible / amperaje 20 amperes	Zekering / zekeringsterkte 20 Ampère
Zigarettenanzünder / Zubehör - Steckdose	cigarette lighter / accessory socket	allume-cigare / prise d'accessoires	accendisigari / presa accessori	encendido de cigarrillos / caja de accesorios	Sigarettenaansteker / accessoires stekkerdoos
Lautsprecher / Warnsummer	loudspeaker / buzzer	haut-parleur / vibreur	autoparlante / cicalino	altavoz / señal acústica de advertencia	Luidspreker / waarschuwingsoemer
Einparkhilfe	park distance control	assistance au parking	sensori di parcheggio	ayuda para aparcar	Inparkeerhulp
Schalter / Funktionsursprung	switch / source of function	interrupteur / origine de fonction	interruttore / origine funzione	interruptor / origen de función	Schakelaar / functieoorsprong
verbinden	Connect together	raccorder	connessione	conectar	Koppelen
trennen	disconnect	séparer	sconnessione	separar	Ontkoppelen
beachten / siehe weitere Informationen	Look at / see further information	considérer / voir informations ultérieures	considerare / vedere ulteriori informazioni	considerar / véase las informaciones	Let op / bekijk verdere informatie
beachte auserwählten Bereich	look carefully at selected area	faire attention à la zone sélectionnée	considerare area selezionata	considerar el área seleccionada	Let op gekozen bereik
vorhanden / belegt / i.o.	Present / Occupied / OK	disponible / occupé / OK	presente / occupato / OK	presente / ocupado / OK	Aanwezig / bezet / i.o.
nicht vorhanden / nicht belegt / nicht i.o.	Not present / Not occupied / not OK	pas disponible / pas occupé / pas OK	non presente / non occupato / non OK	non presente / non ocupado / non OK	Niet aanwezig / niet bezet / niet i.o.
links	left	gauche	sinistra	izquierdo	Links
rechts	right	droite	destra	derecho	Rechts
Akustische Signalisierung	acoustic indication	signalisation acoustique	segnalazione acustica	señalización acústica	Akoestische signalering
Achtung / wichtiger Hinweis	attention / important advice	attention / indication importante	attenzione / indicazione importante	atención / indicación importante	Attentie / belangrijke instructie